

# Family Spas™

Model: FA-1325

2  
0  
2  
4



LTR.2023.1148  
10/11/2024



Cal Spas Home Resorts™

Owner's Manual



Congratulations! You are now the owner of the finest spa built. Now you will experience true comfort and relaxation as you never had before. We at Cal Spas® focus on quality, design and comfort in order to create a truly luxurious experience like no other.

Welcome to the Cal Spas® family.

It is important that you register your Cal Spas product as soon as possible. By taking just a few quick minutes to register, you can enjoy product alerts, more efficient support, and quicker service. Go to <https://calspas.com/register-your-spa.php>. Fill in your information and click "SEND WARRANTY INFO".

### Locating the product serial number

The serial number of your spa is located on a metal plate attached to the right side of the spa panel. You will need this number to properly register your spa and activate coverage. Write this information in the space provided below.

Spa Model: \_\_\_\_\_

Spa Serial Number: \_\_\_\_\_

Date Purchased: \_\_\_\_\_

Date Installed: \_\_\_\_\_

Dealer's Phone Number: \_\_\_\_\_

Dealer's Address: \_\_\_\_\_

Lloyd's Material Supply Company, Inc.

**Lloyd's Material Supply Company, Inc. Copyright 2023. All rights reserved. Duplication without written consent is strictly prohibited.**  
Cal Spas®, Adjustable Therapy System™, ATS™, Cal Premium™, Cal Select™, Cal Stone™, XL™ Heater, and Ultimate Fitness Spa Series™ are registered trademarks.  
Due to continuous improvement programs, all models, operation, and/or specifications are subject to change without prior notice.

LTR.2024.1148

10/11/2024

**CONTACT INFORMATION**  
For customer service, please contact your authorized dealer immediately. If you need additional information and/or assistance, contact:

**Lloyd's Material Supply Company, Inc.  
Customer Service Department  
1462 East Ninth Street  
Pomona, CA 91766.**

Toll Free: 1-800-CAL-SPAS  
Fax: 1-909-629-3890

# Table of Contents

**Important Safety Instructions** 4

Preparing for Your Spa .....6

Planning the Best Location .....6

Service Area Clearance .....7

Foundation Requirements .....7

240 Volt Electrical Specification .....8

Wiring Specifications & GFCI Requirement .....8

GFCI Wiring Diagram .....9

Filling and Powering Up Your Spa .....10

Priming the Pump .....13

Pump and Control Box Placement .....14

**TP-500 Control Panel**

Spa Behavior .....17

Temperature & Temp Range .....18

Heat Modes, Ready & Rest .....19

Setting the Time of Day .....20

Flip Display (Invert) .....20

Restricting Operation (Lock/Unlock) .....21

Hold (Standby) .....22

Adjusting Filtration Cycles .....23

Light Timer .....24

Preferences .....25

Utilities .....26

Fault Log .....27

General Messages .....28

Heater Related Messages .....29

Sensor Related Messages .....30

Misc Messages .....30

System Related Messages .....31

Reminder Messages .....32

Cal Connect Wifi RF Module .....33

Cal Connect Set Up Guide .....34

**Spa Operation/Features**

Electrical Efficiency Tips .....36

Jets & LED Lighting .....36

Diverter Knobs & Air Ventrails .....37

Hydrostreamers .....37

**Water Clarity**

The Four Steps of Water Clarity .....38

Water Quality Terms and Definitions .....39

Water Testing Methods .....40

Adding Chemicals to The Spa .....40

Balancing Water Chemistry Levels .....41

Sanitation and Shock .....42

Filtration & Cleaning .....44

Cleaning the Filter Cartridge .....44

General Water Care Schedule .....45

Generic Names for Chemicals .....45

Common Water Chemistry Questions .....46

Do's and Dont's .....47

Bather Load & Ozonator .....48

Troubleshooting Water Clarity .....48

Chemical Abuse .....49

**Cleaning and Maintenance**

Removing and Re-Seating Pillows .....50

Jet Removal & Replacement .....50

Cleaning the Hydro Streamers .....50

Spa Cover and Locking System .....53

Draining your Portable Spa .....55

Winterization (Cold Climate Draining) .....56

Importance of a Clean Filter .....56

Vacation Care .....56

**Cleaning your Spa**

Spa Cover and Pillows .....57

Spa Shell .....57

Using the Freedom Sound System .....57

Working Out with Your Spa .....59

Air injection/Resistance .....59

Swim Tether .....59

Exercise Equipment .....59

Connecting Exercise Equipment .....59

Anchor Points for Fitness Straps .....60

Anchor Points for Fitness Equipment .....62

**Appendix**

Replacement Parts .....65

Basic Troubleshooting .....73

Thermal Creep .....75

Limited Warranty .....77



# IMPORTANT SAFETY INSTRUCTIONS



## READ AND FOLLOW ALL INSTRUCTIONS CAREFULLY

When using and installing this spa, basic safety precautions should always be followed, including.



### **Danger: RISK OF SEVERE INJURY OR DROWNING!**

- NO DIVING, diving may result in injury or death.
- Do not allow children to be in or around the spa unless a responsible adult supervises them.
- Keep the spa cover on and locked when not in use
- See instructions enclosed with your cover for locking procedures.



### **Danger: SUCTION ENTRAPMENT HAZARD, RISK OF SEVERE INJURY OR DROWNING!**

Suction in suction fittings when broken, damaged, cracked, or unsecured can cause severe injury and or death due to the following entrapment hazards.

- **Body Entrapment:** A negative pressure applied to a large portion of the body or limbs can result in entrapment.
- **Hair Entrapment:** Hair can be sucked in or caught within the suction fitting.
- **Evisceration/Disembowelment Entrapment Risk:** Negative pressure applied directly to the intestines through a damaged/unprotected suction outlet. This can result in Evisceration/Disembowelment.
- The suction fittings in this spa are sized to match the specific water flow created by the pump. Should the need arise to replace the suction fittings, or the pump, be sure the flow rates are compatible.
- The suction fitting is made with chemical resistant plastic, that will last over a finite period of time. This component will degrade and become brittle after constant exposure to sanitizers. When performing maintenance on the spa, inspect suction fittings for any cracks or damage.
- When the spa is in operation, suction is created within the suction fittings. Persons within the spa should not be leaning on, stepping on, or making contact with suction fittings.



### **Danger: RISK OF SEVERE INJURY FROM ELECTRIC SHOCK OR DEATH FROM ELECTROCUTION.**

- Install the spa at least 5 feet (1.5 meters) from all metal surfaces. As an alternative, a spa may be installed within 5 feet (1.5 meters) of metal surfaces if each metal surface is permanently bonded by a minimum of 8 gauge AWG solid copper conductor to the outside of the spas control box.
- DO NOT permit any external electrical appliances, such as lights, telephones, radios, television, etc, within 5 feet (1.5 meters) of the spa. Never attempt to operate any electrical device from inside the spa.
- Replace any damaged power cord immediately.
- Never bury any power cord, a proper conduit must be used.
- Connect to a proper grounding-type receptacle or to a proper grounding post in the GFCI and breaker.



### **Warning: RISK OF HYPERTHERMIA (OVER-HEATING) CAUSING SEVERE INJURY, BURNS, WELTS, OR DEATH**

- Water temperature in excess of 104°F (40°C) may be detrimental for your health.
- The spa water should never exceed 104°F (40°C). Water temperatures between 100°F (38°C) and 104°F (40°C) are considered safe for a healthy adult.
- Lower water temperatures are recommended for young children, and when the spa use exceeds 10 minutes.
- Before using the spa, the user should measure the water temperature since the tolerance of water temperature regulating devices varies.
- **Do not use the spa if drugs, alcohol, or prescription medications were consumed before or during use. In an altered state of mind, the human body can not react properly to changes in temperature. This increases your risk of hyperthermia, injury, drowning, or death.**



 **Warning: REDUCE RISK OF HEAT RELATED INJURY OR DEATH**



- Prolonged exposure to hot air or water can induce hyperthermia. Hyperthermia occurs when the internal temperature of the body reaches a level between 3°F (2°C) to 6°F (4°C) above the normal body temperature of 98.6°F (37°C). While using warm spa water has many health benefits, its important to make sure that your body's core temperature does not rise above 103°F (39.5°C).
- High water temperatures have a high potential for causing fetal damage during pregnancy. Women who are pregnant, or think they are pregnant should always check with their physician prior to spa usage.
- The use of alcohol, drugs or medication before or during spa use may lead to unconsciousness, with the possibility of drowning.
- Persons suffering from obesity, a medical history of heart disease, low or high blood pressure, circulatory system problems or diabetes should consult a physician before using the spa.
- Persons using medications should consult a physician before using the spa since some medications may induce drowsiness or impair judgment. Other medications or drugs may affect heat rate, blood pressure and circulation.

 **HYPERTHERMIA**

- Symptoms of excessive hyperthermia include dizziness, lethargy, drowsiness and fainting. The effects if excessive hyperthermia may include:
  - Failure to perceive heat
  - Failure to recognize the need to exit the spa
  - Unawareness to impending hazards
  - Fetal damage to pregnant woman
  - Physical inability to exit spa
  - Unconsciousness

 **Swim Spa Temperatures**

- When using a swim spa for exercise or for leisurely swimming, never set the swim spa water temperature above 80°F. Temperatures above 80°F can hinder the bodies ability to cool down and cause unnecessary cardiovascular stress.

 **WARNING:** People with infectious diseases or diarrhea should not use a spa or hot tub. **WARNING:** To avoid injury, exercise caution when entering or exiting the spa/swim spa. **WARNING:** Do not use the spa or swim spa immediately following strenuous exercise. **WARNING:** Prolonged immersion in a spa or hot tub may be injurious to your health. **CAUTION:** Maintain water chemistry in accordance with the manufacture's instructions. **WARNING: NO DIVING, diving may result in injury or death.**

## READ AND SAVE THESE INSTRUCTIONS

# Preparing for Your New Portable Spa

## Pre-Delivery Checklist

Thank you for purchasing our Family Fun spa welcome to the Calspas Family.

Most cities and counties require permits for exterior construction and electrical circuits.

In addition, some communities have codes requiring residential barriers such as fencing and/or self-closing gates on property to prevent unsupervised access to the property by children. Your dealer can provide information on which permits may be required and how to obtain them prior to the delivery of the spa.

### Before Delivery

- Plan your delivery route
- Choose a suitable location for the spa
- Lay a 4-6 inch concrete slab
- Install dedicated electric supply

### After Delivery

- Place spa on Slab
- Connect electrical components

## Planning the Best Location

### Safety First

Do not place your spa within 10 feet (3m) of overhead power lines.

### Consider How You Will Use Your Spa

How you intend to use your spa will help you determine where you should position it. Your spa is mainly used for family recreation be sure to leave plenty of room around it for activity. If you will use it for relaxation and therapy, you will probably want to create a specific mood around it.

### Plan for Your Environment

If you live in a region where it snows in the winter or rains frequently, place the spa near a house entry. By doing this, you will have a place to change clothes and not be uncomfortable.

### Consider Your Privacy

In a cold-weather climate, bare trees won't provide much privacy. Think of your spa's surroundings during all seasons to determine your best privacy options. Consider the view of your neighbors as well when you plan the location of your spa.

### Provide a View with Your Spa

Think about the direction you will be facing when sitting in your spa. Do you have a special landscaped area in your yard that you find enjoyable? Perhaps there is an area that catches a soothing breeze during the day or a lovely sunset in the evening.

### Keep Your Spa Clean

In planning your spa's location, consider a location where the path to and from the house can be kept clean and free of debris.

Prevent dirt and contaminants from being tracked into your spa by placing a foot mat at the spa's entrance where the bathers can clean their feet before entering your spa.

### Allow for Service Access

Make sure the spa is positioned so that access to the equipment compartment and all side panels will not be blocked.

Many people choose to install a decorative structure around their spa. If you are installing your spa with any type of structure on the outside, such as a gazebo, remember to allow access for service. It is always best to design special installations so that the spa can still be moved, or lifted off the ground.

While you are planning where to locate your spa, you need to determine how much access you will need for service.

All spa models require a minimum of three feet / one meter access to all sides of the spa for potential service. For this reason, the spa should never be placed in a manner where any side is permanently blocked. Examples include placing the spa against a building, structural posts or columns, or a fence.

Spa models require access to all sides in case they need service or repair. See the figure to the right.

If you are planning to enclose or surround your spa with a deck, make sure there is easy access for service or repair.

**NOTE: Spas require clearance on all sides of the spa.**

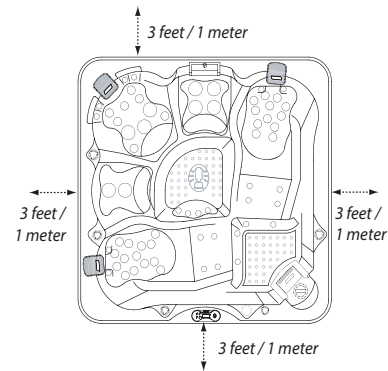

## Foundation Requirements

**NOTE: We strongly recommend that a qualified, licensed contractor prepare the foundation for your spa. Damage caused by inadequate or improper foundation support is not covered by the warranty. It is the responsibility of the spa owner to provide a proper foundation for the spa.**

Your spa needs a solid and level foundation. The area that it sits on must be able to support the weight of the spa, with water and occupants who use it. If the foundation is inadequate, it may shift or settle after the spa is in place, causing stress that could DAMAGE YOUR SPA SHELL AND FINISH. Place the spa on an elevated 3 to 4" / 30 cm concrete slab. Pavers, gravel, brick, sand, timbers or dirt foundations are **not** adequate to support the spa. If you are installing the spa indoors, pay close attention to the flooring beneath it. Choose flooring that will not be damaged or stained. If you are installing your spa on an elevated wood deck or other structure, it is highly recommended that you consult a structural engineer or contractor to ensure the structure will support the weight of 150 lbs per square foot (732 Kg/m<sup>2</sup>).

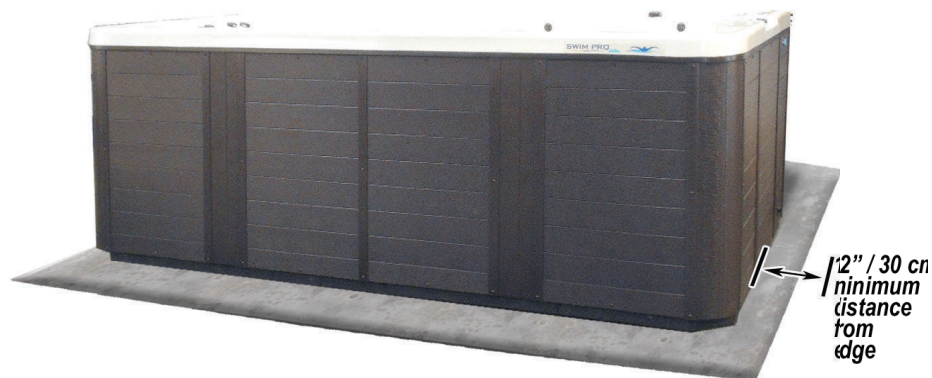

## 240 Volt Electrical Specifications

**NOTE: These instructions describe the only acceptable electrical wiring procedure. Spas wired in any other way will void your warranty and may result in serious injury. The electrical circuit must be installed by an electrical contractor and approved by a local building or electrical inspector. Failure to comply with state and local codes may result in a fire or personal injury and will be the sole responsibility of the spa owner.**

All 240V spas must be permanently connected (hard wired) to the power supply. When installed in the United States, the electrical wiring of this spa must meet the requirements of the NEC 70 and any applicable local, state, and federal codes. The power supplied to the spa must be on a dedicated GFCI protected circuit as required by NEC 70 with no other appliances or lights sharing the power. Use copper wire with THHN insulation. DO not use aluminum wire. Use the table below to determine your GFCI and wiring requirements. Wires that run over 100 feet must increase wire gauge to the next lower number. For example: A normal 50 amp GFCI with four #6 AWG copper wires that run over 100 feet would require you to go to four #4 AWG copper wires.

### Wiring Specifications and GFCI Requirement

Spa Model	Control System	GFCI Breaker	Wires Required
FA-1325	BP501X	One 50 Amp GFCI Breaker	Four #6 AWG Copper Wires

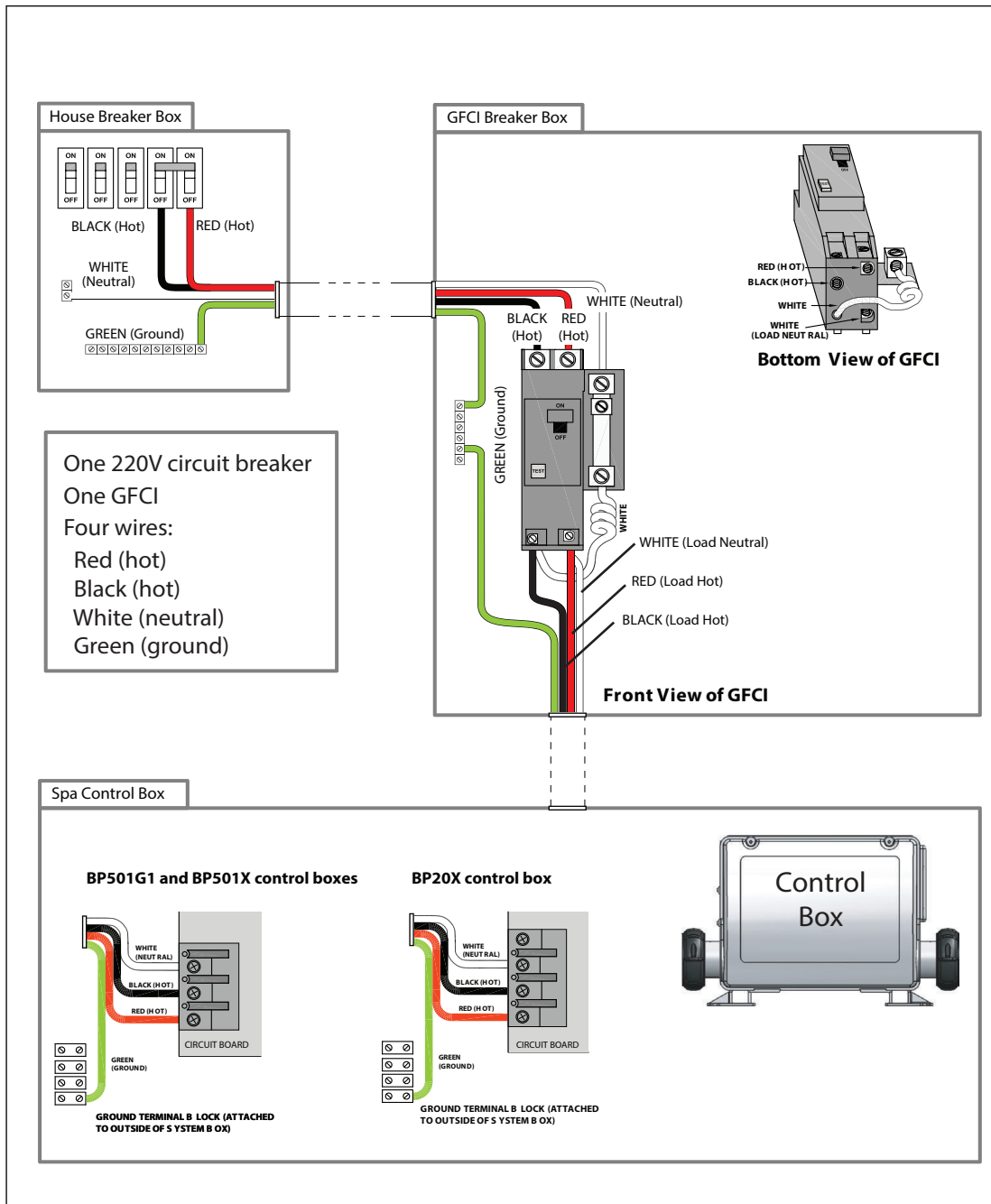



## Filling and Powering Up your Portable Spa

### Step 1. Inspect the Spa Equipment.

Inspect all plumbing connections in the equipment area of your spa.

- Make sure unions connected to the equipment pack are tight (do not over-tighten)
- If your spa has gate valves, make sure they are in the upright position.
- Make sure the drain valve is closed and capped.

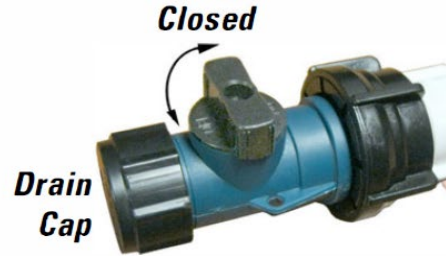
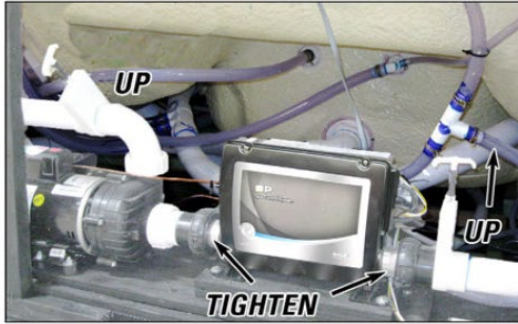

**Note:** Never run the spa with the gate valve closed or without circulating water for long periods of time.

### Step 2. Remove the Filter Cartridge.

If you have a skimmer like this:



#### Teleweir filter skimmer

- 50 square feet filtration
- Spoked cap

Rotate and remove the locking ring (Color may vary). Remove the skimmer cap and barrel, grip the filter by the handle and unscrew it from the canister. Replace and lock the locking ring and slid the skimmer cap and barrel back into the canister. Once the spa is filled you can remove the skimmer cap and barrel again to reinstall the filter.



The skimmer and barrel are locked in place during shipping with a retainer ring. The retainer ring must be unlocked and removed in order to slide the skimmer upward to remove the filter cartridge.



When removing the filter cartridge, you may remove the filter by turning it counter clockwise. The filter must be removed gently to not damage the threaded fitting inside of the filter canister.



After removing the filter, reinstall the retainer ring to the canister, then reinstall the skimmer, this skimmer must be able to move up and down with your water level. In the following step you will fill your spa with water through the filter canister.

### Step 3. Fill the Spa

Place the water hose inside the filter canister. Fill your spa with regular tap water about six inches from the top. If the water level is too low or too high, your spa will not operate correctly.

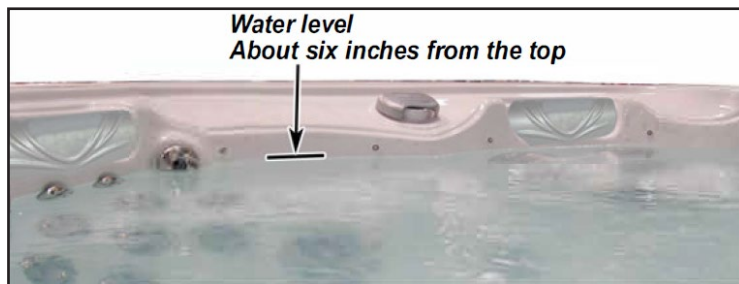

**NOTE: Never fill with soft water.**

Soft water made through some home filtration systems make it impossible to maintain proper water chemistry, and may cause water foaming. This can damage the finish of the spa and void your warranty.

**You may fill your spa with well water, but only if the following preconditions are followed.**

1. Purchase and use a pre-filter that can attach to the end of a hose. This pre-filter is absolutely necessary in order to remove reactive metals and other dissolved solids that are found in well water.
2. Perform a Total Dissolved Solids (TDS) and metals test, this can be performed by a qualified person after filling up the spa, before initial use. Most Dealers and pool supply stores can perform this test.

### Step 4. Power Your Spa

When the spa is filled to the correct level, turn on the power at the GFCI breaker (ensure that the 120V spas are connected to their dedicated proper electrical outlet.)



### Step 5. Prime the Main Pump

The system will enter priming mode when powered up for the first time. **Priming Mode** will scroll through the display on the control panel. In this mode all devices including pumps and lights are operable, you may press the jet buttons on and off to help prime the pumps. After a few minutes the system will exit priming mode.

**Step 6.** Install filter into the filter canister

**Note:** Make sure you have removed and soaked the spa filter cartridge in a bucket of water for at least 30 minutes. This will remove air pockets inside of the filter.

When re installing the filter cartridge, do not over tighten the filter, the threaded bit inside of the filter housing is made of a corrosion resistant ABS plastic. Excessive torque will break the internal threads within the filter housing.

**Step 7.** Test and Adjust Water Chemistry

Test and adjust the water chemistry.

**Step 8.** Let the Spa Heat Up

After a period of 5-15 minutes the priming mode will finish. The heater will then activate, put the spa cover on and let the spa heat to the desired set temperature.

During the initial power up the spa, it will consume a large amount of energy to raise the water in the tub to your desired hot tub temperature. Cal Spas are designed for high efficiency, once the temperature within the spa is reached, the spa will use lower amounts of energy to maintain the temperature.

**Note:** Cal Spas are designed to retain heat, if it is desired to lower the water temperature the spa does not contain a cooling feature. To lower internal temperature of the spa, lower the set temperature on the control panel and open the tub during the evening or night to help release the heat captured within. You may also drain 1/4 of the water within and refill with new water to lower temperatures rapidly.

New owners often have difficulty the first time they start their spa and the pumps fail to prime. This can be frustrating but these instructions should help you resolve any issues with air pockets inside of the primary pump or other priming issues.

Sometimes air can become trapped in the primary pump while filling up the spa, although this should be preventable by filling your spa through the filter basket, there is a chance that an air pocket can still form even when following the proper steps. Initially it may seem that the pump is not working, with some sound coming from the pump but no water movement.

**Note: When a pump has an airlock, continuing to operate the pump experiencing an air pocket issue can damage the pump. Do not operate the pump until this airlock issue is fixed.**

### Start Up: Priming Mode

When the spa is powered up for the first time, the spa will enter priming mode. During this mode all devices within the spa is operational. You may wait for 10-15 minutes for the heater to engage, this period of time resets when a secondary pump is activated or if the primary pump is activated for high speed.

**The spa will automatically exit priming mode.**

### Bleeding Air from the Pump

IF you have tried priming the pump by pressing the jet or jet 1 button on and off again with no results, you will need to bleed the pump manually.

1. Shut off power to the spa.
2. Using a philips head screwdriver, remove the front panel from the spa directly underneath the control panel, and locate the main pump.
3. Ensure that the gate valves are open
4. Place rags or towels under the plastic wet end of the pump where the spa plumbing connects into the pump
5. On the plastic wet end there will be a plastic hex headed bleeder valve that can be opened to bleed air trapped inside of the pump
6. Do not fully remove the nut, there are grooves within the nut that allows air to escape. Water will begin to trickle once the air pocket has been removed, tighten down the screw again with light torque.
7. If bleeding the pump is unsuccessful, loosen the pump unions with plumbing channel locks to remove any trapped air between the pump and the heater.
8. Turn the spa power back on and press the Jet button to prime the pump again.

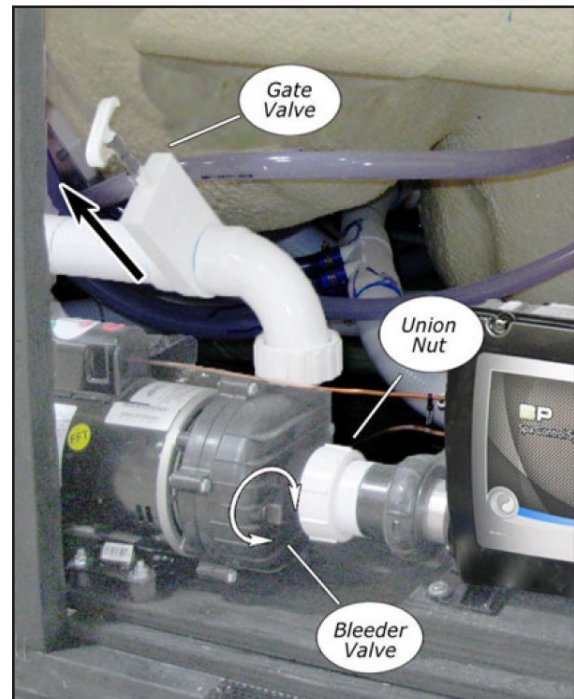

# Pump and Control Box Placement Diagrams

Note: All Spas including swim spas require a minimum of 3 feet clearance on all sides for accessibility for technicians to perform repairs or maintenance. Service providers may charge a fee for poor access which would require movement of the spa by crane or removal of objects/decks obstructing access.

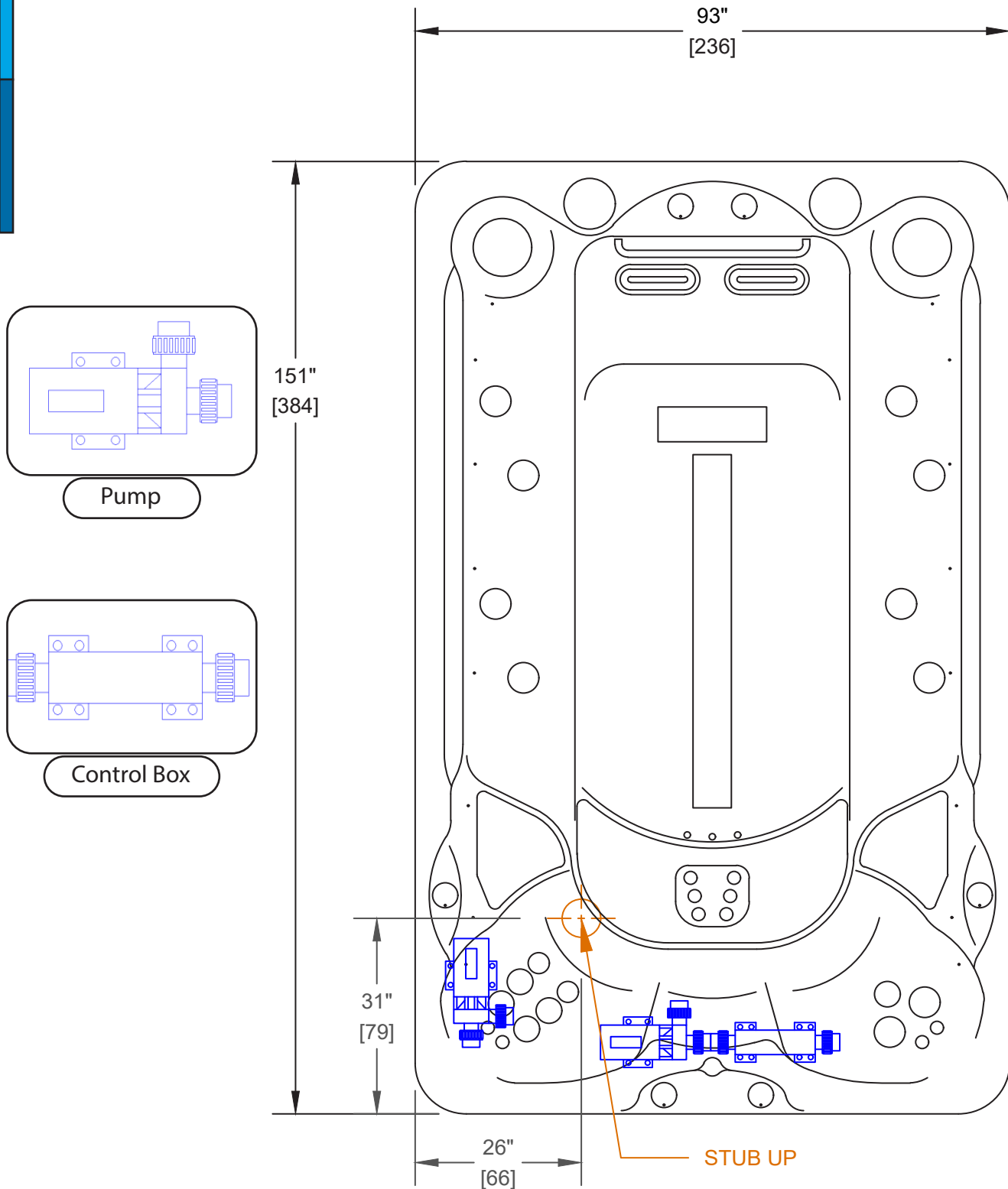



# Main Menus

## Navigation / TP-500

Navigating the entire menu structure is done with 2 or 3 buttons on the control panel.



Some panels have separate WARM (Up) and COOL (Down) buttons, while others have a single Temperature button. In the navigation diagrams Temperature buttons are indicated by a single button icon.

Panels that have two Temperature buttons (Warm and Cool) can use both of them to simplify navigation and programming where a single Temperature icon is shown. The MENU/SELECT Button is used to choose the various menus and navigate each section.

Typical use of the Temperature button(s) allows changing the Set Temperature while the numbers are flashing in the LCD. The menus can be exited with certain button presses. Simply waiting for a few seconds will return the panel operation to normal.

### Power-up Screens

Each time the System powers up, a series of numbers is displayed. After the startup sequence of numbers, the system will enter Priming Mode

### Key

- Indicates Flashing or Changing Segment
- Indicates Alternating or Progressive Message - every 1/2 second
- A temperature button, used for "Action"
- Menu/Select button

- Waiting time that keeps the last change to a menu item.
- \*\*\*\*\* Waiting time (depends on menu item) that reverts to original setting and ignores any change to that menu item.

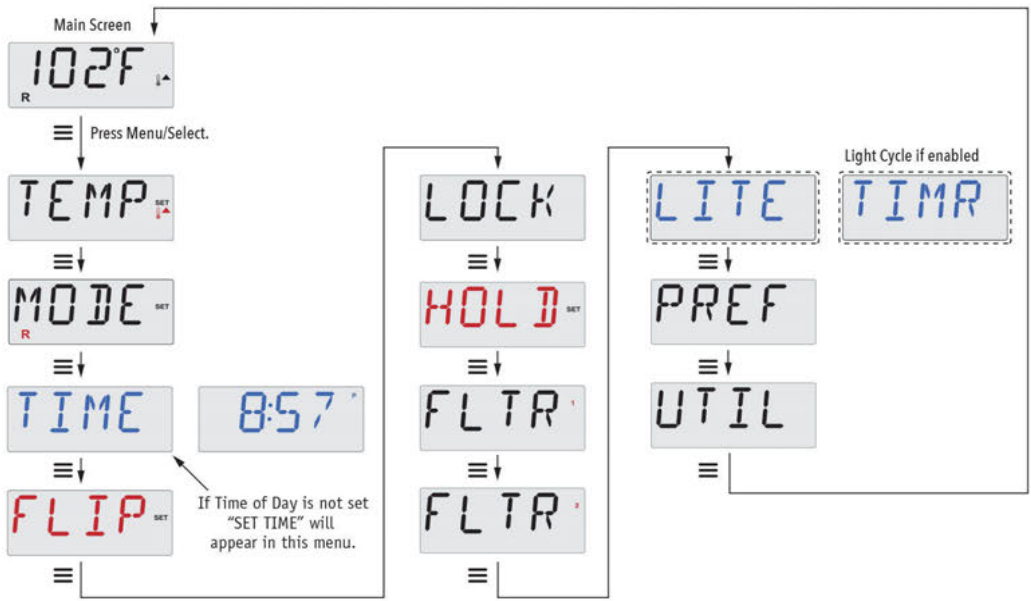

Indicates a Menu Item that Depends on a Manufacturer Configuration and may or may not appear.



Waiting a few seconds in the Main Menu will allow the display to revert to the Main Screen. Most changes are not saved unless Menu/Select is pressed. Refer to key above.

# Fill it up!

## Preparation and Filling

Fill the spa to its correct operating level. Be sure to open all valves and jets in the plumbing system before filling to allow as much air as possible to escape from the plumbing and the control system during the filling process.

After turning the power on at the main power panel, the top-side panel display will go through specific sequences. These sequences are normal and display a variety of information regarding the configuration of the hot tub control.

## Priming Mode - MO19\*

This mode will last for 4-5 minutes or you can manually exit the priming mode after the pump(s) have primed.



Regardless of whether the priming mode ends automatically or you manually exit the priming mode, the system will automatically starts normal heating and filtering at the end of the priming mode. During the priming mode, the heater is disabled to allow the priming process to be completed without the possibility of energizing the heater under low-flow or no-flow conditions. Nothing comes on automatically, but the pump(s) can be energized by pushing the "Jets" or "Aux" buttons.

If the spa has a Circ Pump, it can be activated by pressing the "Light" button during Priming Mode.

## Priming the Pumps

As soon as the above display appears on the panel, push the "Jets" button once to start Pump 1 in low-speed and then again to switch to high-speed. Also, push the "Jets 2" or "Aux" button, if you have a 2nd pump, to turn it on. The pumps will now be running in high-speed to facilitate priming. If the pumps have not primed after 2 minutes, and water is not flowing from the jets in the spa, do not allow the pumps to continue to run. Turn off the pumps and repeat the process. Note: Turning the power off and back on again will initiate a new pump priming session. Sometimes momentarily turning the pump off and on will help it to prime. Do not do this more than 5 times. If the pump(s) will not prime, shut off the power to the spa and call for service.

Important: A pump should not be allowed to run without priming for more than 2 minutes. Under NO circumstances should a pump be allowed to run without priming beyond the end of the 4-5 minute priming mode. Doing so may cause damage to the pump and cause the system to energize the heater and go into an overheat condition.

## Exiting Priming Mode

You can manually exit Priming Mode by pressing the "Warm" or "Cool" button. Note that if you do not manually exit the priming mode as described above, the priming mode will be automatically terminated after 4-5 minutes. Be sure that the pump(s) have been primed by this time.

Once the system has exited Priming Mode, the top-side panel will momentarily display the set temperature but the display will not show the water temperature yet, as shown below.

This is because the system requires approximately 1 minute of water flowing through the heater to determine the water temperature and display it.



# Spa Behavior

---

## Pumps

Press the “Jets” button once to turn pump 1 on or off, and to shift between low and high speeds if equipped. If left running, the pump will turn off after a time-out period.

On non-circ systems, the low-speed of pump 1 runs when the blower or any other pump is on. If the spa is in Ready Mode (See page 6), Pump 1 low may also activate once in a while for at least 1 minute to detect the spa temperature (polling) and then to heat to the set temperature if needed. When the low-speed turns on automatically, it cannot be deactivated from the panel, however the high speed may be started.

### Circulation Pump Modes

If the system is equipped with a circ pump, it will be configured to work in one of three different ways:

- 1, The circ pump operates continuously (24 hours) with the exception of turning off for 30 minutes at a time when the water temperature reaches 3°F (1.5°C) above the set temperature (most likely to happen in very hot climates).
- 2, The circ pump stays on continuously, regardless of water temperature.
- 3, A programmable circ pump will come on when the system is checking temperature (polling), during filter cycles, during freeze conditions, or when another pump or blower is on.

The specific Circulation Mode that is used has been determined by the Manufacturer and cannot be changed in the field.

## Filtration and Ozone

On non-circ systems, Pump 1 low and the ozone generator will run during filtration. On circ systems, the ozone will run with the circ pump.

The system is factory-programmed with one filter cycle that will run in the evening (assuming the time-of-day is properly set) when energy rates are often lower. The filter time and duration are programmable.

A second filter cycle can be enabled as needed.

At the start of each filter cycle, all water devices (other than the primary pump) will run briefly to purge the plumbing to maintain good water quality. The term “water devices” includes the Blower.

## Freeze Protection

If the temperature sensors within the heater detect a low enough temperature, then the pump(s) and the blower automatically activate to provide freeze protection. The pump(s) and blower will run either continuously or periodically depending on conditions.

In colder climates, an optional freeze sensor may be added to protect against freeze conditions that may not be sensed by the standard sensors. Auxiliary freeze sensor protection acts similarly except with the temperature thresholds determined by the switch. See your dealer for details.

## Clean-up Cycle (optional)

When a pump or blower is turned on by a button press, a clean-up cycle begins 30 minutes after the pump or blower is turned off or times out. The pump and the ozone generator will run for 30 minutes or more, depending on the system. On some systems, you can change this setting.



# Temperature and Temp Range

## Adjusting the Set Temperature

When using a panel with Up and Down buttons (Temperature buttons), pressing Up or Down will cause the temperature to flash. Pressing a temperature button again will adjust the set temperature in the direction indicated on the button. When the LCD stops flashing, the spa will heat to the new set temperature when required.

If the panel has a single temperature button, pressing the button will cause the temperature to flash. Pressing the button again will cause the temperature to change in one direction (e.g. UP). After allowing the display to stop flashing, pressing the Temperature Button will cause the temperature to flash and the next press will change the temperature in the opposite direction (e.g. DOWN).

## Press-and-Hold

If a Temperature button is pressed and held when the temperature is flashing, the temperature will continue to change until the button is released. If only one temperature button is available and the limit of the Temperature Range is reached when the button is being held, the progression will reverse direction.

## Dual Temperature Ranges

This system incorporates two temperature range settings with independent set temperatures. The High Range designated in the display by a thermometer and an "up" arrow, and the Low Range designated in the display by a thermometer and "down" arrow.

These ranges can be used for various reasons, with a common use being a "ready to use" setting vs. a "vacation" setting. The Ranges are chosen using the menu structure below. Each range maintains its own set temperature as programmed by the user. This way, when a range is chosen, the spa will heat to the set temperature associated with that range.

For example:

*High Range might be set between 80°F and 104°F.*

*Low Range might be set between 50°F and 99°F.*

*More specific Temp Ranges may be determined by the Manufacturer*

*Freeze Protection is active in either range.*

### Key

- Indicates Flashing or Changing Segment
- Indicates Alternating or Progressive Message - every 1/2 second
- ⏏ A temperature button, used for "Action"
- ☰ Menu/Select button

- Waiting time that keeps the last change to a menu item.
- \*\*\*\*\* Waiting time (depends on menu item) that reverts to original setting and ignores any change to that menu item.

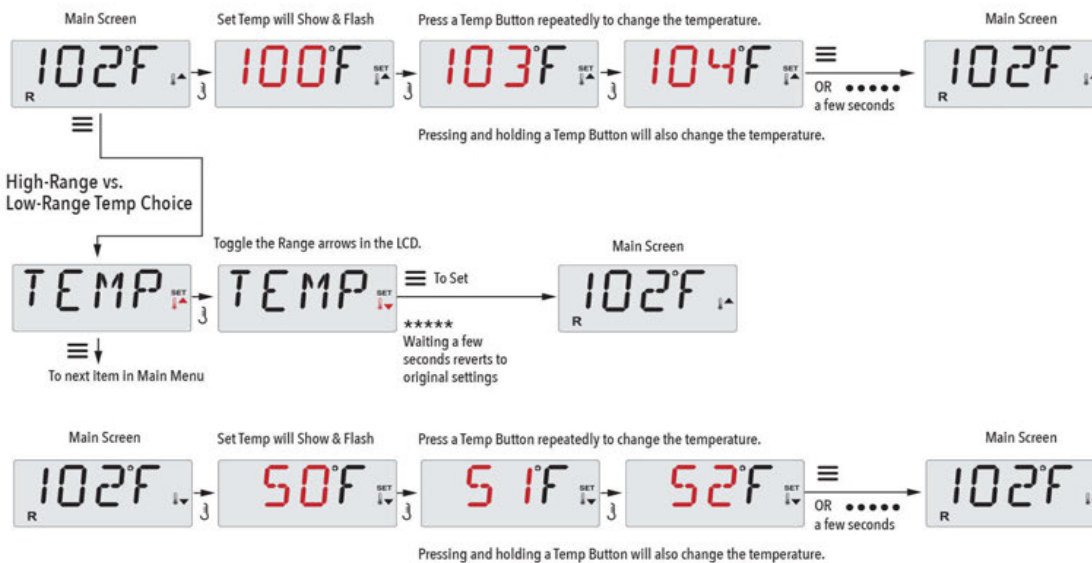

# Mode – Ready and Rest

In order for the spa to heat, a pump needs to circulate water through the heater. The pump that performs this function is known as the "primary pump."

The primary pump can be either a 2-Speed Pump 1 or a circulation pump.

If the primary pump is a 2-Speed Pump 1, Ready Mode (indicated by **R**) will circulate water periodically, using Pump 1 Low, in order to maintain a constant water temperature, heat as needed, and refresh the temperature display. This is known as "polling."

Rest Mode (indicated by **R**) will only allow heating during programmed filter cycles. Since polling does not occur, the temperature display may not show a current temperature until the primary pump has been running for a minute or two.

Circulation Mode (See Page 4, under Pumps, for other circulation modes)

If the spa is configured for 24HR circulation, the primary pump generally runs continuously. Since the primary pump is always running, the spa will maintain set temperature and heat as needed in Ready Mode, without polling.

In Rest Mode, the spa will only heat to set temperature during programmed filter times, even though the water is being filtered constantly when in Circulation Mode.

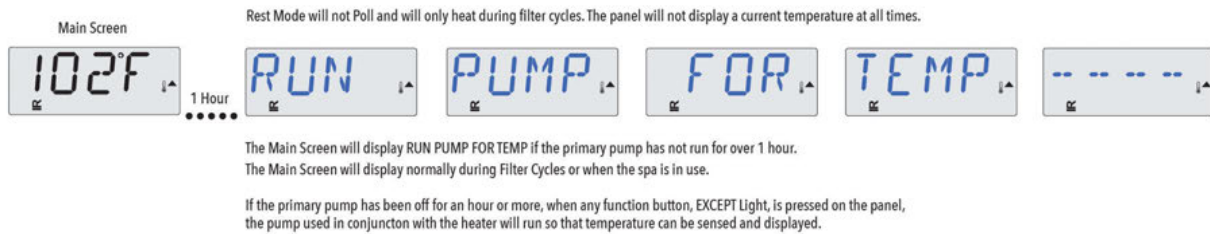
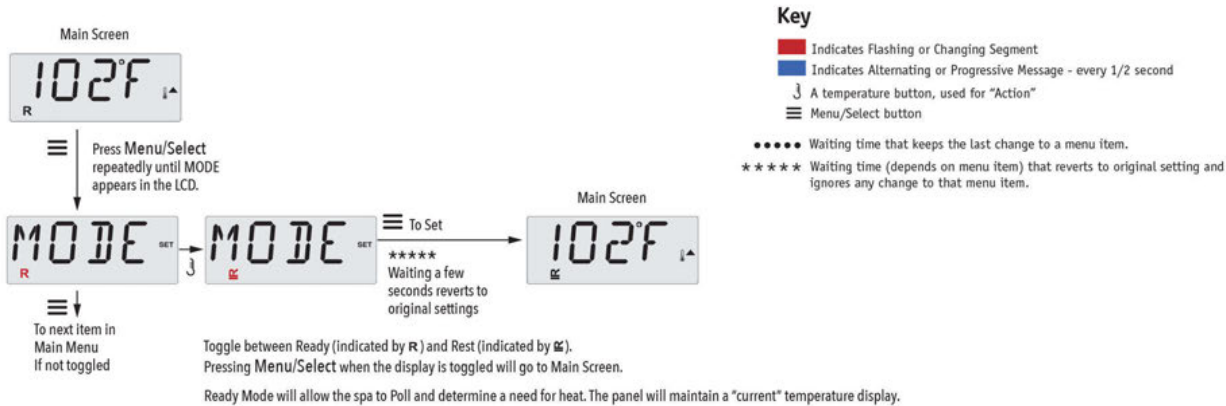

## Ready-in-Rest Mode

**R** **R** appears in the display if the spa is in Rest Mode and "Jets" is pressed. It is assumed that the spa is being used and will heat to set temperature. The primary pump will run until set temperature is reached, or 1 hour has passed. After 1 hour, the System will revert to Rest Mode. This mode can also be reset by entering the Mode Menu and changing the Mode.

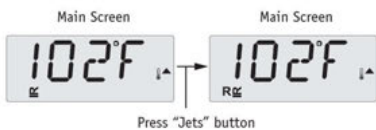



# Show and Set Time-of-Day

Be sure to set the Time-of-Day

Setting the time-of-day can be important for determining filtration times and other background features.

When in the TIME menu, SET TIME will flash on the display if no time-of-day is set in the memory.

24-hour time display can be set under the PREF menu.

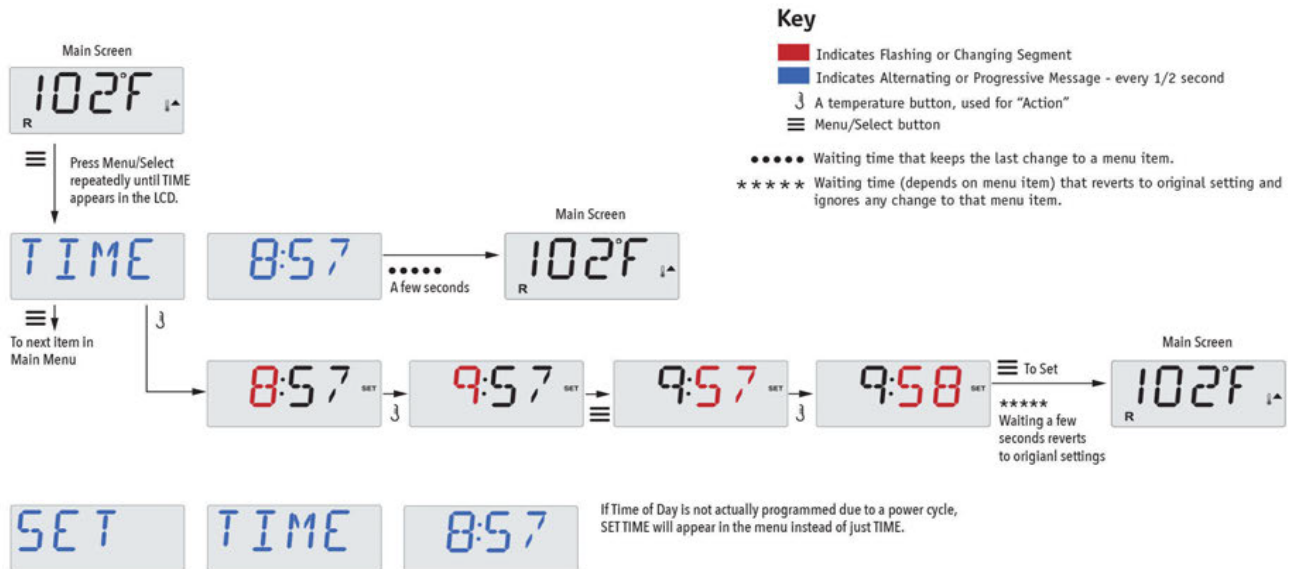

## Note:

This note refers to systems that do not keep track of Time-of-Day when powered down.

If power is interrupted to such a system, Time-of-Day is not stored. The system will still operate and all other user settings will be stored. If filter cycles are required to run at a particular time of day, resetting the clock will return the filter times to the actual programmed periods.

When such a system starts up, it defaults to 12:00 Noon, so another way to get filter times back to normal is to start up the spa at noon on any given day. SET TIME will still flash in the TIME Menu until the time is actually set, but since the spa started at noon, the filter cycles will run as programmed.

# Flip (Invert Display)

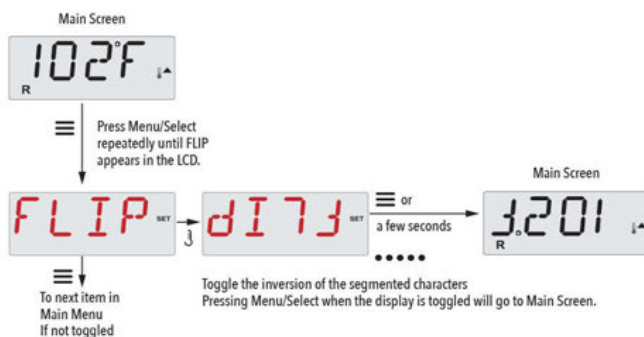

# Restricting Operation

The control can be restricted to prevent unwanted use or temperature adjustments.

Locking the panel prevents the controller from being used, but all automatic functions are still active.

Locking the Temperature allows Jets and other features to be used, but the Set Temperature and other programmed settings cannot be adjusted.

Temperature Lock allows access to a reduced selection of menu items. These include Set Temperature, FLIP, LOCK, UTIL, INFO and FALT LOG.

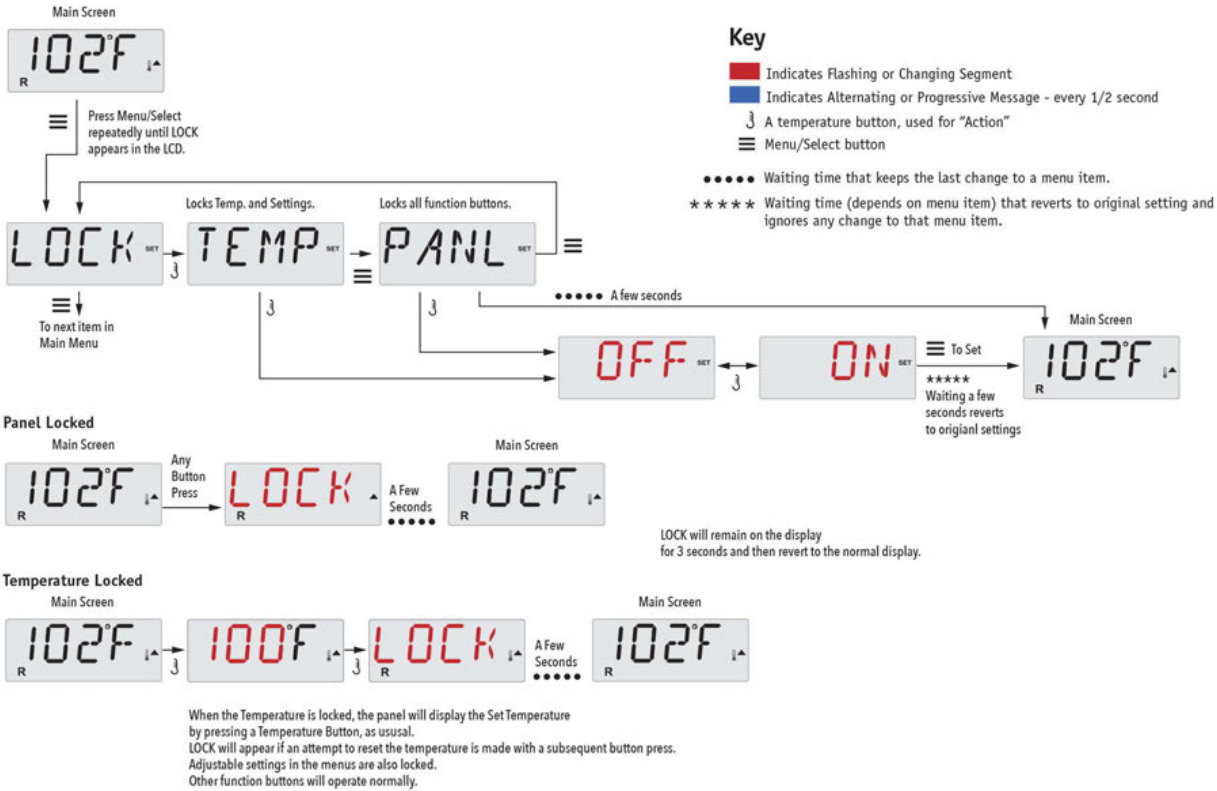

# Unlocking

This Unlock sequence may be used from any screen that may be displayed on a restricted panel.

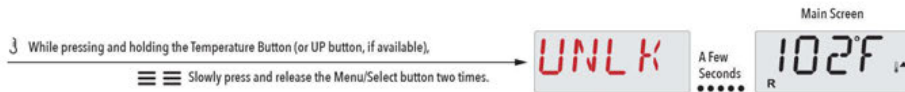

NOTE: If the panel has both an UP and a Down button, the ONLY button that will work in the Unlock Sequence is the UP button.

The temperature will not Unlock if the Unlock sequence is done while the panel is displaying "LOCK".

# Hold (Standby)

## Hold Mode –M037\*

Hold Mode is used to disable the pumps during service functions like cleaning or replacing the filter. Hold Mode will last for 1 hour unless the mode is exited manually.

## Drain Mode

Some spas have a special feature that allows a pump to be employed when draining the water.

When available, this feature is a component of Hold Mode.

Drain Mode will time out with Hold Mode.

### Key

- Indicates Flashing or Changing Segment
- Indicates Alternating or Progressive Message - every 1/2 second
- ⌋ A temperature button, used for "Action"
- ☰ Menu/Select button
- Waiting time that keeps the last change to a menu item.
- \*\*\*\* Waiting time (depends on menu item) that reverts to original setting and ignores any change to that menu item.

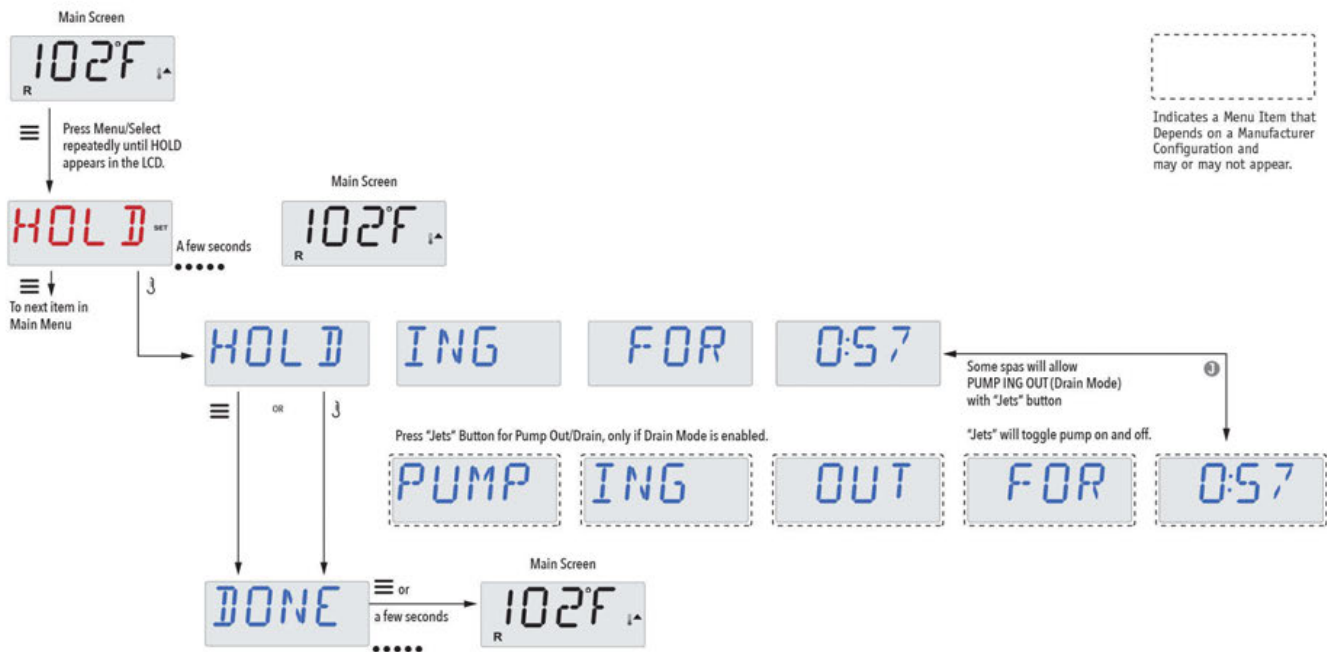

Indicates a Menu Item that Depends on a Manufacturer Configuration and may or may not appear.

# Adjusting Filtration

## Main Filtration

Filter cycles are set using a start time and a duration. Start time is indicated by an "A" or "P" in the bottom right corner of the display. Duration has no "A" or "P" indication. Each setting can be adjusted in 15-minute increments. The panel calculates the end time and displays it automatically.

- Key**
- Indicates Flashing or Changing Segment
  - Indicates Alternating or Progressive Message - every 1/2 second
  - ⏏ A temperature button, used for "Action"
  - ☰ Menu/Select button
  - Waiting time that keeps the last change to a menu item.
  - \*\*\*\*\* Waiting time (depends on menu item) that reverts to original setting and ignores any change to that menu item.

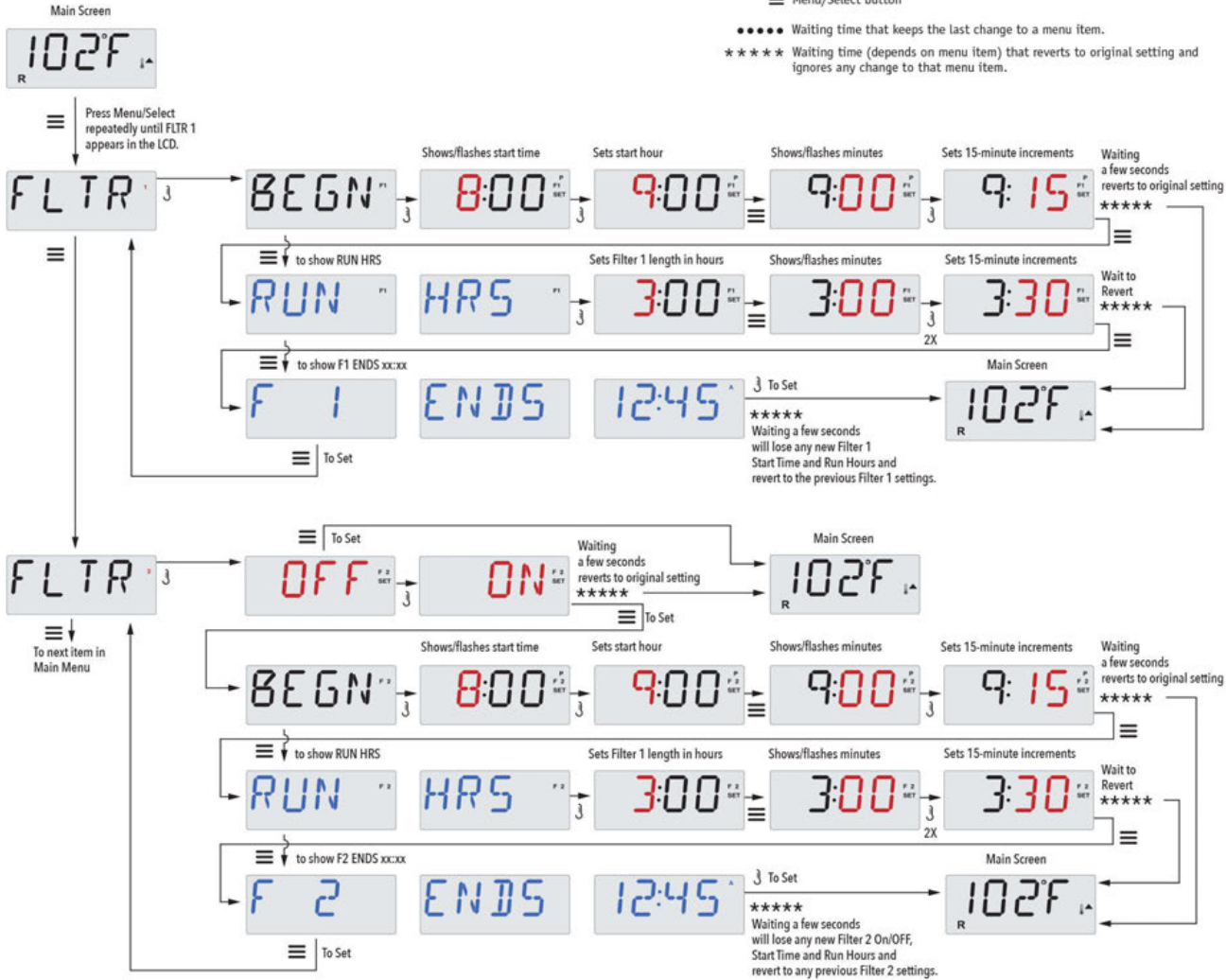

## Filter Cycle 2 - Optional Filtration

Filter Cycle 2 is OFF by default. It is possible to overlap Filter Cycle 1 and Filter Cycle 2, which will shorten overall filtration by the overlap amount.

## Purge Cycles

In order to maintain sanitary conditions, secondary Pumps and/or a Blower will purge water from their respective plumbing by running briefly at the beginning of each filter cycle.

If Filter Cycle 1 is set for 24 hours, enabling Filter Cycle 2 will initiate a purge when Filter Cycle 2 is programmed to begin.



# Light Timer Programming

## Light Timer Option

If LITE TIMR does not appear in the Main Menu, the Light Timer feature is not enabled by the manufacturer.

When available, the Light Timer is OFF by default.

### Key

- Indicates Flashing or Changing Segment
- Indicates Alternating or Progressive Message - every 1/2 second
- ⌋ A temperature button, used for "Action"
- ☰ Menu/Select button

- Waiting time that keeps the last change to a menu item.
- \*\*\*\*\* Waiting time (depends on menu item) that reverts to original setting and ignores any change to that menu item.



Indicates a Menu Item that Depends on a Manufacturer Configuration and may or may not appear.

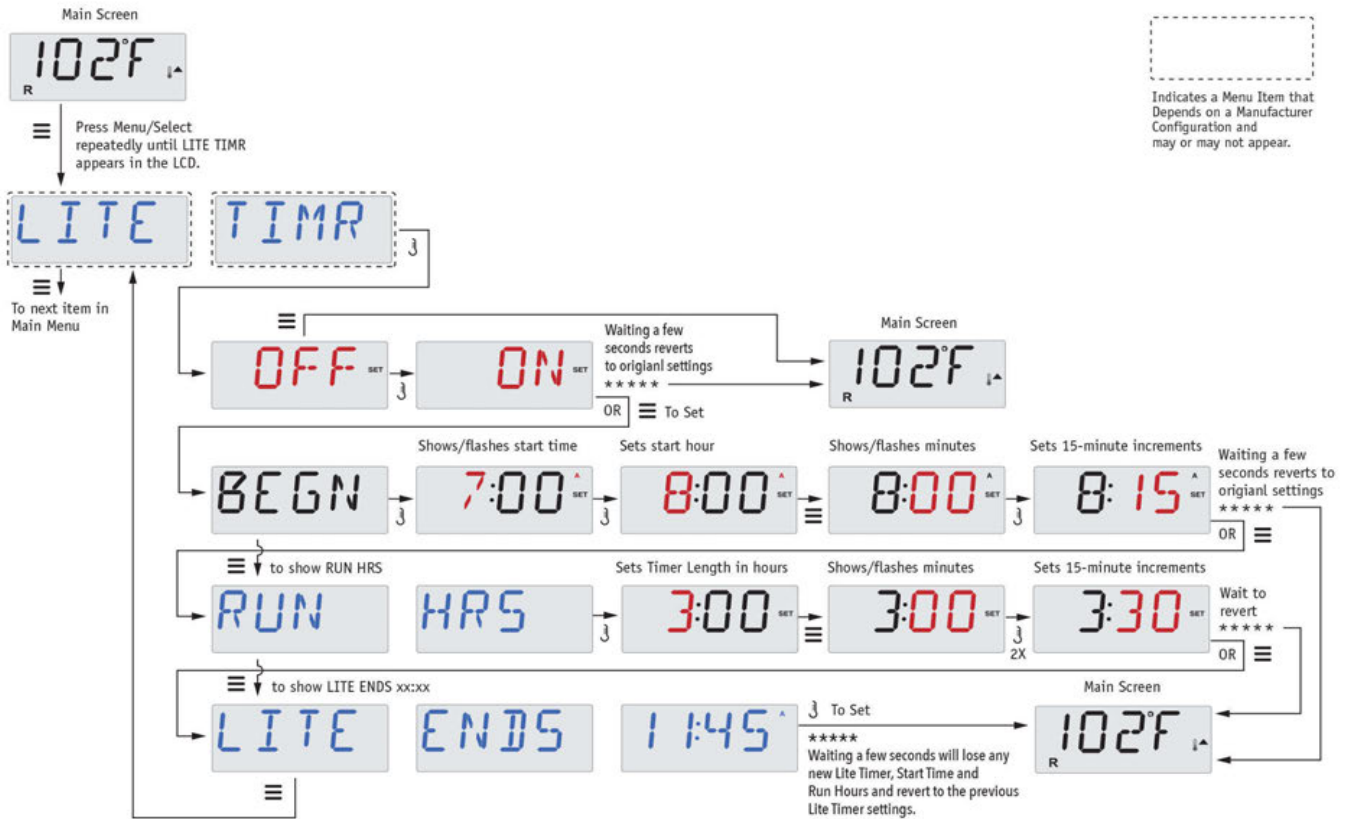



# Preferences

- Key**
- Indicates Flashing or Changing Segment
  - Indicates Alternating or Progressive Message - every 1/2 second
  - ⌋ A temperature button, used for "Action"
  - ☰ Menu/Select button
  - Waiting time that keeps the last change to a menu item.
  - \*\*\*\*\* Waiting time (depends on menu item) that reverts to original setting and ignores any change to that menu item.

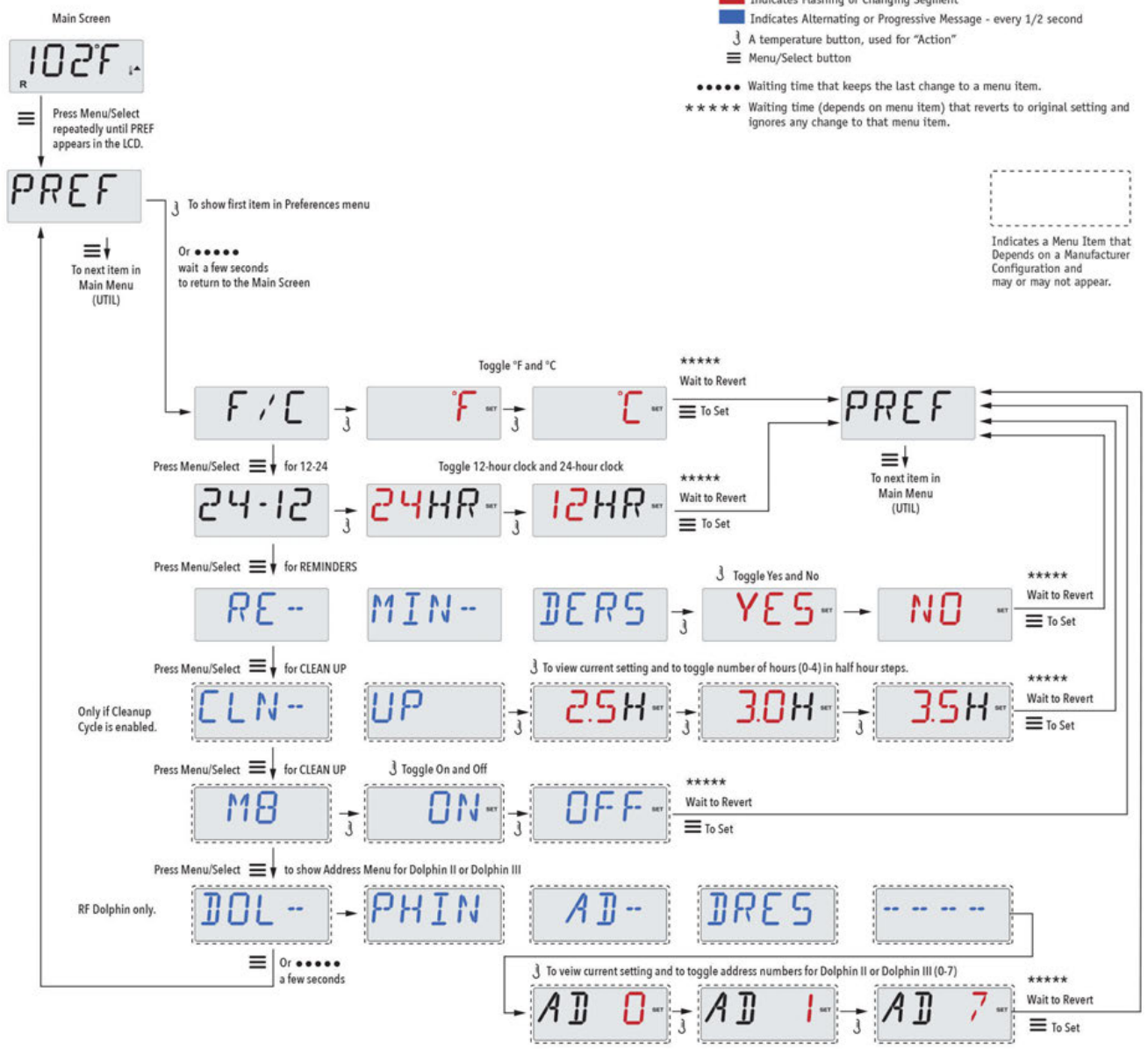

# Utilities

### Key

- Indicates Flashing or Changing Segment
- Indicates Alternating or Progressive Message - every 1/2 second
- ⌋ A temperature button, used for "Action"
- ≡ Menu/Select button

- Waiting time that keeps the last change to a menu item.
- \*\*\*\*\* Waiting time (depends on menu item) that reverts to original setting and ignores any change to that menu item.

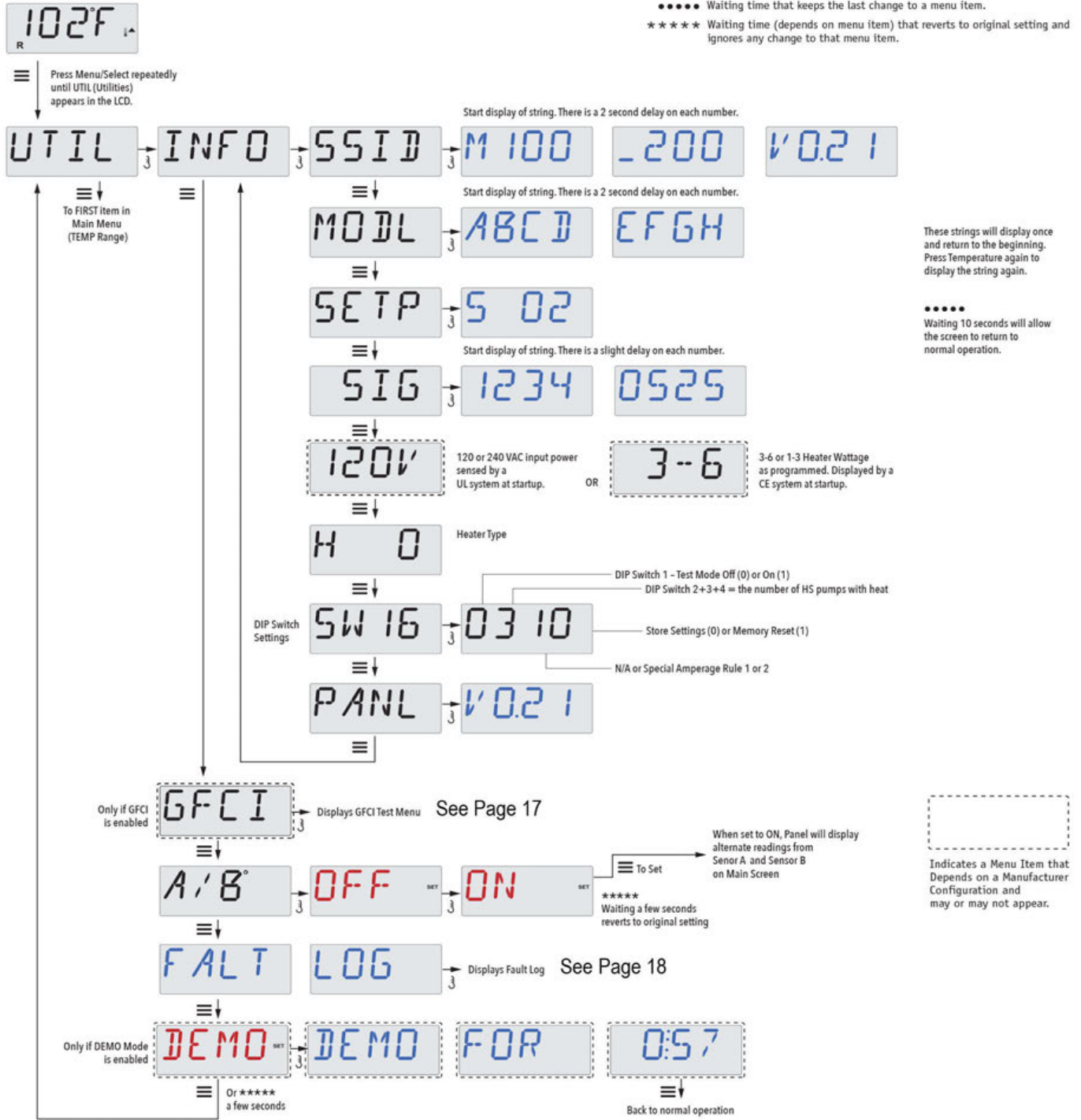

# Utilities – Fault Log

## A Little History can tell a lot

The Fault Log stores up to 24 events in memory and they can be reviewed under the Fault Log Menu.

Each event captures a Fault Message Code, how many days have passed since the fault, Time of the fault, Set Temperature during the fault, and Sensor A and B temperatures during the fault.

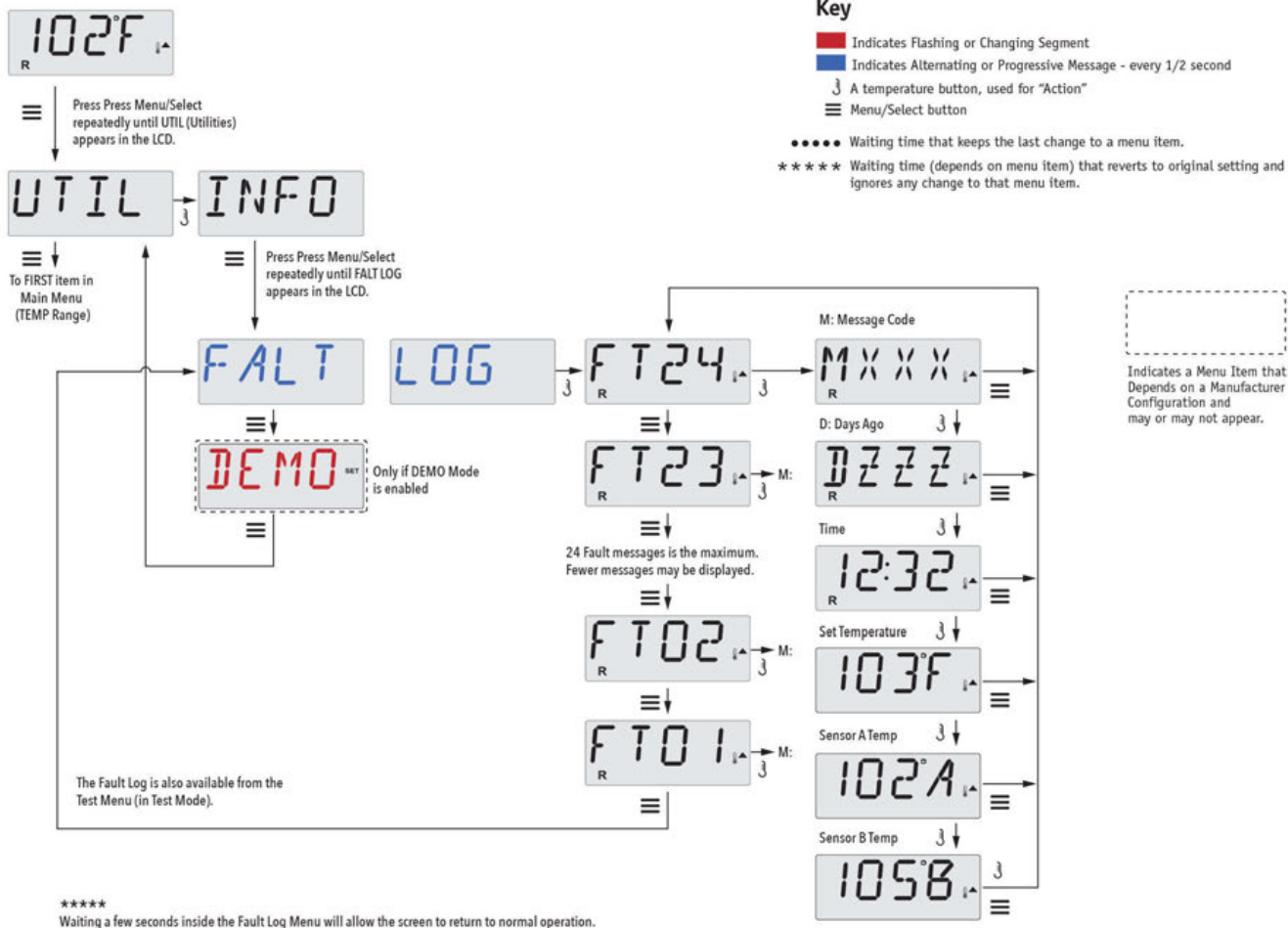

# General Messages



## Priming Mode – MO19

Each time the spa is powered up, it will enter Priming Mode. The purpose of Priming Mode is to allow the user to run each pump and manually verify that the pumps are primed (air is purged) and water is flowing. This typically requires observing the output of each pump separately, and is generally not possible in normal operation. Priming Mode lasts 4 minutes, but you can exit it earlier by pressing any Temp button. The heater is not allowed to run during Priming Mode.

NOTE: If your spa has a Circ Pump, it will turn on with "Light" in Priming Mode. The Circ Pump will run by itself when Priming Mode is exited.



## Water Temperature is Unknown

After the pump has been running for 1 minute, the temperature will be displayed.



## Too Cold - Freeze Protection

A potential freeze condition has been detected, or the Aux Freeze Switch has closed, and all pumps and blower are activated, either one at a time, or all at once, depending on how your system was built. All pumps and blower are ON for at least 4 minutes after the potential freeze condition has ended, or when the aux freeze switch opens.

In some cases, pumps may turn on and off and the heater may operate during Freeze Protection.

This is an operational message, not an error indication.



## Water is too Hot (OHS) – MO29

One of the water temp sensors has detected spa water temp 110°F (43.3°C) and spa functions are disabled. System will auto reset when the spa water temp is below 108°F (42.2°C). Check for extended pump operation or high ambient temp.



## J29 Warning – MO44

J29 is typically used as a Heater Disable input. As such, it should not typically be shorted at power-up. This message appears if J29 is shorted at power-up.



# Heater-Related Messages



## Heater Flow is Reduced (HFL) – MO16

There may not be enough water flow through the heater to carry the heat away from the heating element. Heater start up will begin again after about 1 min. See "Flow Related Checks" below.



## Heater Flow is Reduced (LF)\* – MO17

There is not enough water flow through the heater to carry the heat away from the heating element and the heater has been disabled. See "Flow Related Checks" below. After the problem has been resolved, you must press any button to reset and begin heater start up.



## Heater may be Dry (dr)\* – MO28

Possible dry heater, or not enough water in the heater to start it. The spa is shut down for 15 min. Press any button to reset the heater start-up. See "Flow Related Checks" below.

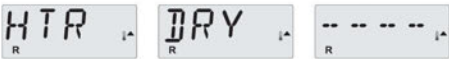

## Heater is Dry\* – MO27

There is not enough water in the heater to start it. The spa is shut down. After the problem has been resolved, you must press any button to reset and restart heater start up. See "Flow Related Checks" below.



## Heater is too Hot (OHH)\* – MO30

One of the water temp sensors has detected 118°F (47.8°C) in the heater and the spa is shut down. You must press any button to reset when water is below 108°F (42.2°C). See "Flow Related Checks" below.



## A Reset Message may Appear with other Messages.

Some errors may require power to be removed and restored.

## Flow-Related Checks

Check for low water level, suction flow restrictions, closed valves, trapped air, too many closed jets and pump prime.

On some systems even when spa is shut down, some equipment may occasionally turn on to continue monitoring temperature or if freeze protection is needed.

\* This message can be reset from the topside panel with any button press.

## Sensor-Related Messages

102°F<sub>R</sub> SNSR<sub>R</sub> BAL --<sub>R</sub> ANCE<sub>R</sub>

### Sensor Balance is Poor – MO15

The temperature sensors MAY be out of sync by or 3°F. Call for Service.

SNSR<sub>R</sub> SYNC<sub>R</sub> -- -- -- --<sub>R</sub> CALL<sub>R</sub> FOR<sub>R</sub> SRVC<sub>R</sub> -- -- -- --<sub>R</sub>

### Sensor Balance is Poor\* – MO26

The temperature sensors ARE out of sync. The Sensor Balance is Poor fault has been established for at least 1 hour. Call for Service.

SNSR<sub>R</sub> A<sub>R</sub> -- -- -- --<sub>R</sub> CALL<sub>R</sub> FOR<sub>R</sub> SRVC<sub>R</sub> -- -- -- --<sub>R</sub>

B<sub>R</sub>

### Sensor Failure – Sensor A: MO31, Sensor B: MO32

A temperature sensor or sensor circuit has failed. Call for Service.

## Miscellaneous Messages

NO<sub>R</sub> COMM<sub>R</sub>

### No Communications

The control panel is not receiving communication from the System. Call for Service.

BETA<sub>R</sub> VER --<sub>R</sub> SION<sub>R</sub> -- -- -- --<sub>R</sub>

### Pre-Production Software

The Control System is operating with test software. Call for Service.

102°T<sub>R</sub>

°F or °C is replaced by °T

The Control System is in Test Mode. Call for Service.

# System-Related Messages



## Memory Failure - Checksum Error\* – MO22

At Power-Up, the system has failed the Program Checksum Test. This indicates a problem with the firmware (operation program) and requires a service call.



## Memory Warning - Persistent Memory Reset\* – MO21

Appears after any system setup change. Contact your dealer or service organization if this message appears on more than one power-up, or if it appears after the system has been running normally for a period of time.

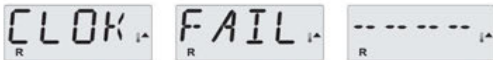

## Memory Failure - Clock Error\* – MO20 - Not Applicable on the BP1500

Contact your dealer or service organization.

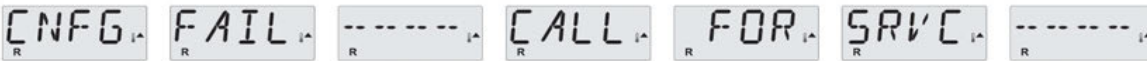

## Configuration Error – Spa will not Start Up

Contact your dealer or service organization.

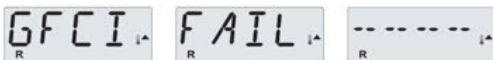

## GFCI Failure - System Could Not Test/Trip the GFCI – MO36

NORTH AMERICA ONLY. May indicate an unsafe installation. Contact your dealer or service organization.

# System-Related Messages



## A Pump Appears to be Stuck ON – MO34

Water may be overheated. POWER DOWN THE SPA. DO NOT ENTER THE WATER. Contact your dealer or service organization.



## A Pump Appears to have been Stuck ON when spa was last powered - MO35

POWER DOWN THE SPA. DO NOT ENTER THE WATER.  
Contact your dealer or service organization.



## The water level is too low

Some systems have a water level detect, and this message appears if it detects that the water level is too low.

# Reminder Messages

---

## General maintenance helps.

The display of Reminder Messages can be suppressed by using the PREF Menu.

Reminder Messages can be chosen individually by the Manufacturer. They may be disabled entirely, or there may be a limited number of reminders on a specific model.

The frequency of each reminder (e.g. 7 days) can be specified by the Manufacturer.

Press a Temperature button to reset a displayed reminder message.

---

Alternates with temperature or normal display.

## Appears on a regular schedule, e.g. every 7 days.

Check pH with a test kit and adjust pH with the appropriate chemicals.

---

Alternates with temperature or normal display.

## Appears on a regular schedule, e.g. every 7 days.

Check sanitizer level and other water chemistry with a test kit and adjust with the appropriate chemicals.

---

Alternates with temperature or normal display.

## Appears on a regular schedule, e.g. every 30 days.

Clean the filter media as instructed by the manufacturer.

---

Alternates with temperature or normal display.

## Appears on a regular schedule, e.g. every 30 days.

The Ground Fault Circuit Interrupter (GFCI) or Residual Current Device (RCD) is an important safety device and must be tested on a regular basis to verify its reliability.

Every user should be trained to safely test the GFCI or RCD associated with the hot tub installation.

A GFCI or RCD will have a TEST and RESET button on it that allows a user to verify proper function.

## Warning:

If freezing conditions exist, a GFCI or RCD should be reset immediately or spa damage could result. The end user should always be trained to test and reset the GFCI or RCD on a regular basis.



# Cal Connect RF Set Up Guide

**Congratulations!** Welcome to Cal Connect Control My Spa, the smart control system for spa monitoring on the go. With Cal Connect you will be able to control/monitor water temperature, control pump operation, adjust filtration, and monitor/control any activity occurring within your spa.

This Quick Start guide will help you with initial set up of your RF module.

**NOTE: The Cal Connect Module works on 2.4 Ghz networks only. Inspect your router to confirm 2.4 Ghz support.**

The Cal Connect uses two modules, one that connects to the home router and one that connects to the spas control box, both modules must have matching serial numbers located on the back of each of the modules. Connect your home module first before proceeding.

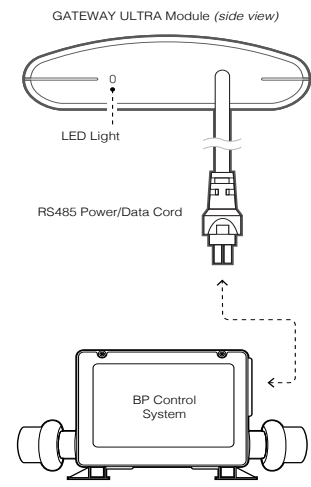
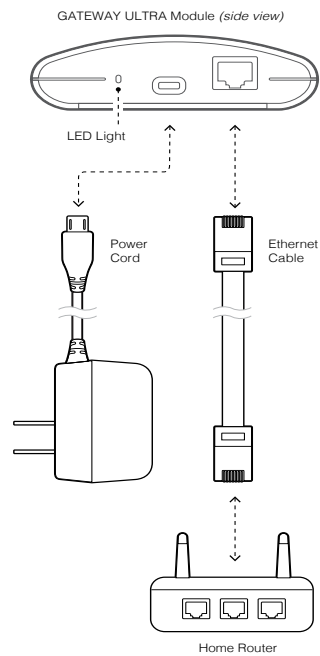
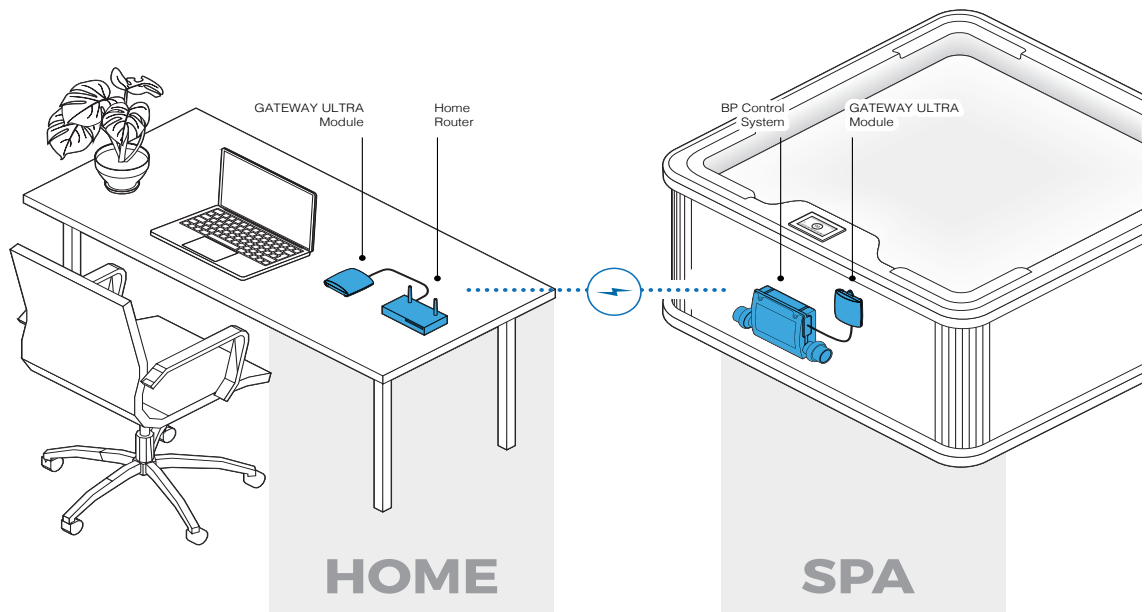

## Download the Control My Spa App

To Begin the initial set up of the Cal Connect system, download the "Control My Spa" app by Balboa Water Group from the App Store or Google Play Store.

Before starting the app, have your CMS code in hand. This is a unique code provided to you by your dealer.

**If you do not have a CMS Code, Please Contact your dealer.**

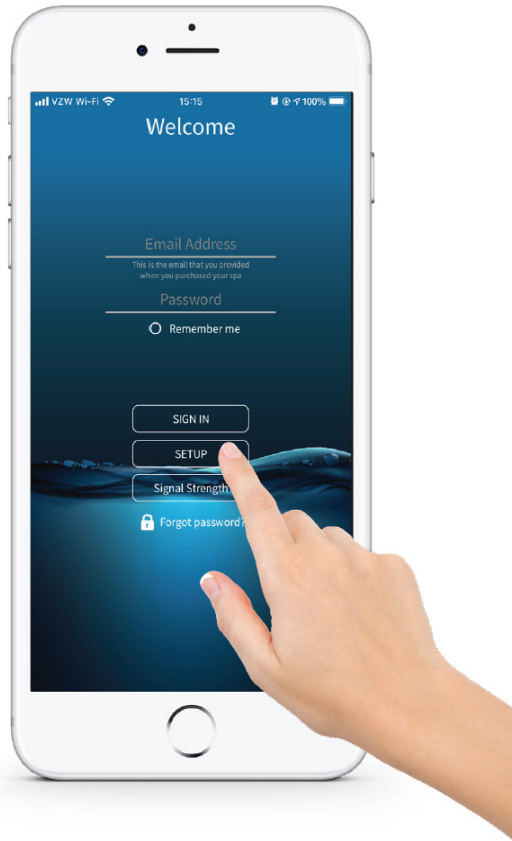
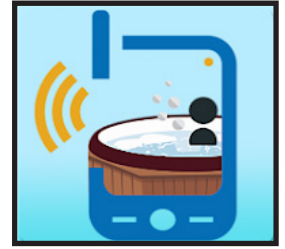

**1-** In your phone setting ensure that your bluetooth setting is toggled on, during initial set up the module uses bluetooth to communicate.

**2-** To set your module into discovery mode, flip your spa GFCI breaker off and back on again.

**3-** Next, open the Control My Spa app and select "SETUP" to begin the process of registering your modules.

**4-** Stand next to the spa, preferably near the control panel of your spa. your mobile device will begin searching for the spa module.

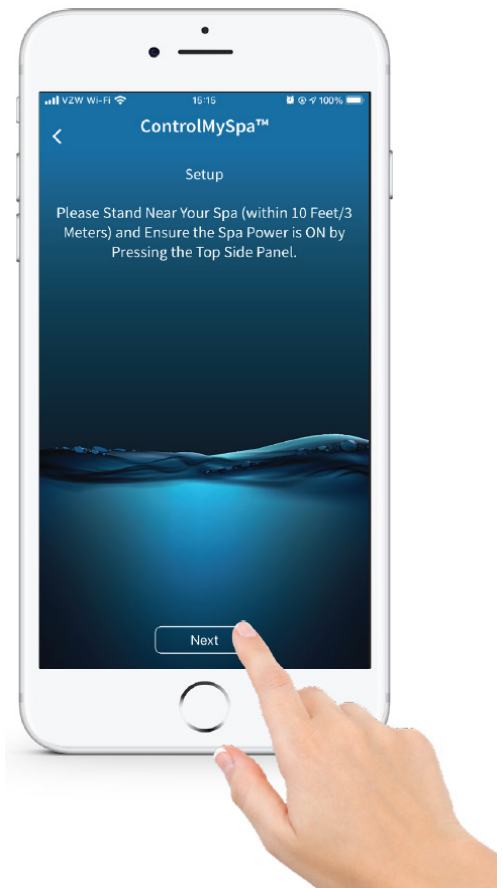

# Control My Spa Set-Up



5- The App will begin scanning for the spas wifi module. within a few seconds the module serial number should appear.

6- Select the "Yes" option once the serial number appears on screen and proceed with the following steps.

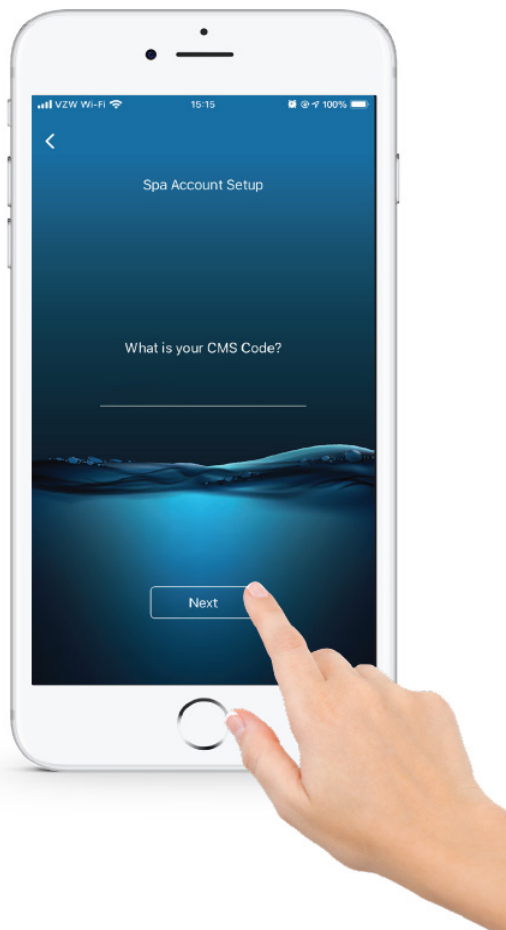

7- The app will request your CMS Code to proceed with creating an account to control your spa.

**If a CMS Code was not given to you, please contact your dealer.**

8- Proceed with account creation, once completed with all steps log into your newly created account on the main page of the app. once you are logged in you should have control of your spa system within 5-10 minutes.

For more details on installation and basic troubleshooting you can download the complete installation/owners manual on <https://www.balboawatergroup.com/getdoc.cfm?id=2392> To download the full manual.



## Electrical Power Efficiency Tips

Your new spa comes equipped with a premium 5.5kWh titanium electric heater. Follow the directions listed below, it will help ensure the most efficient spa operation. Some models have the option to combine your spa with a Gecko “in-Temp” heat pump, this information is still relevant to spa owners with either the 5.5 kWh heater or the add on heat pump .

Note: This method is only for spa usage under two hours a week.

- Keep the spa operating temperature about 5F below your usual preferred temperature when not in use. Raise the temperature to your preferred temp about one or two hours before you enter the spa to save on energy costs if your usage is within the range of two hours per week.
- If you use your spa more than two hours a week total, keep the set temperature at your desired temperature.
- The air venturis should be used sparingly when open, water temperature drops depending on ambient temperature as this air is now being injected into the water.

Allowing the water temperature to lower more than 10F below the desired usage temperature, and reheating it prior to usage, will cause the heater to operate longer than keeping the spa about 5F below. This will increase your operating costs. We recommend getting your spa up to your desired temperature, and then lowering the set temperature by 5F once its reaches the desired temperature. Our spas are designed to retain as much heat as possible to ensure your save on long term costs.

*\*Note: The most electrical power is consumed in the initial fill up, as the tap water needs to be brought up to hot tub temperatures.*

## Jets

Almost all of the jets in your spa are adjustable. Rotating the jet face clockwise will increase water pressure, and counter clockwise to reduce pressure on that specific jet. Neck jets are the opposite, with clockwise movement to decrease force, counter clockwise to increase.



## LED Lighting

Press the “Light” button on the topside controller to turn the spa light on. If your spa has optional perimeter LED lights, they will also activate.

1. **Cycle:** When you press the “Light” button on and off repeatedly the LED will cycle between a variety of colors that the RGB light can support. Each time you press the button it will immediately advance to the next color in sequence and will eventually enter different light pattern modes.
2. **Flashing:** Once you have cycled through all of the colors, another press of the “Light” button will produce a flashing pattern.
3. **Fading cycle:** The next phase of operation when you push the LIGHT button is a slower and/or fast fade random transition from one color to the next.
  - If a spa is equipped with more than 100 points of light the slow fading cycle will flicker during a color change.
  - Every air valve is equipped with 2 LED points.
  - The waterfall takes 4 points of light. Spas with exterior LEDs work in the same mode as described above. The variations in color and patterns provide you multiple customization options.



## Diverter Knobs

Diverter knobs are 1" and 2" knobs located around the top of your spa. They allow you to divert water through jets from one side of the spa to the other, of in most cases from floor jets to all jets. This is accomplished by rotating the diverter knob to the left (counter-clockwise), decreasing the amount of water flow through a section of jets. To increase the amount of water flow through the other section of jets, rotate the handle to the right (clockwise)



## Air Venturis

Air venturis are the 1" knobs located around the top of your spa. Each one will let you add a mixture of air with the jet pressure. This is accomplished by rotating the air venturi knob to the left (counter clockwise) to increase the amount of air flow. To decrease the amount of airflow through the jets, rotate the handle to the right (clockwise)



## Hydro Streamers

Your spa may include two to eight streamer waterfalls. When the booster pump is on, turn the 1" diverter knob to adjust the rate of flow to the waterfall jets.

The waterfall jet faces are not adjustable. Do not turn the jet faces because you may accidentally remove them. Always shut off water to the hydro streamer jets before you place the cover on the spa. Water from the hydro streamer jets sprays in an arc that is higher than the top surface of the spa. When water from the hydro streamer sprays the bottom of the cover, it will collect and run to the edge of the spa and drip over the top.



## Water Clarity

This section is intended for new spa owners who are not familiar with adjusting spa water chemistry. Everyone's knowledge with maintaining water quality is different, but there are some general concepts you need to know.

Water maintenance is not difficult, however it is something that requires regular attention. The most important thing to understand about taking care of your spa water, is that preventative action is easier than corrective action when balancing chemistry and maintaining water clarity

Before beginning, we recommend you become familiar with some water quality terms and their definitions within this following section.

### Four Steps of Water Clarity

#### 1. Chemical Balancing

**Learning how to properly balance your water.**

You will need to test and adjust the chemical balance of your spa water, this is not a difficult task but it must be done regularly. Important areas to focus on with water chemistry is the calcium hardness, total alkalinity, and the pH range.

Spa owners with salt generators will need to perform a total dissolved solids and phosphate test.

#### 3. Filtration

**Learn how to properly clean your filter**

Cleaning your filter cartridge is the easiest and most effective thing you can do to keep your spa water clear.

A clogged dirty filter will cause the heater and pump to work harder than they need to, possibly causing them to fail.

The spa's heating system will only function with the proper amount of water flow through the system.

#### 2. Sanitation and Shock

**Learning how to properly sanitize and shock your spa.**

Sanitizers kill bacteria and viruses and keeps your water clean. A low sanitizer level will allow microbes to grow quickly in the spa water . We recommend using either granulated chlorine or bromine as your sanitizer.

You also need to add shock to the water to stimulate the chemical sanitizer. How much you use and how often you use sanitizers, depends on how frequently the spa is used.

#### 4. Consistency

**Make checking your spa part of your daily routine.**

Clear water requires regular maintenance. Establish a routine based on a regular schedule, testing your water on a daily basis.

Maintaining your water quality helps the enjoyment of your spa and extends the lifetime of spa components by preventing damage from neglect and chemical abuse.

The following chemical terms are used in this section. Understanding their meaning will help you to better understand clear water maintenance. Words in bold type are defined in this table.

<b>Bromine / Bromamines</b>	<p><u>Bromine</u> is an efficient sanitizer chemical for spas. When used as a <b>sanitizer</b>, bromine forms compounds called bromamines. Bromine can be added to the spa or automatically generated.</p> <p><u>Bromamines</u> are compounds formed when bromine combines with nitrogen from body oils, perspiration, etc. Unlike chloramines, bromamines have no pungent odor and are effective sanitizers.</p>
<b>Chlorine / Chloramines</b>	<p><u>Chlorine</u> is an efficient sanitizing chemical for spas. We recommend using sodium dichlor-type granulated chlorine because it is totally soluble and nearly <b>pH</b> neutral. When used as a <b>sanitizer</b>, chlorine forms compounds called chloramines.</p> <p><u>Chloramines</u> are compounds formed when chlorine combines with nitrogen from body oils, perspiration, etc. Chloramines can cause eye irritation as well as having a strong odor. Unlike <b>bromamines</b>, chloramines are weaker, slower <b>sanitizers</b>. To remove chloramines, see the description of <b>shock</b> below.</p>
<b>Calcium Hardness</b>	<p>Abbreviated as CH. Calcium hardness is a measure of the total amount of dissolved calcium in the water. Calcium helps control the <b>corrosive</b> nature of the spa's water and is why soft water is not recommended. The low CH level can cause <b>corrosion</b> to the equipment and can cause staining of the spa shell.</p>
<b>Corrosion</b>	<p>The gradual wearing away of metal spa parts, usually caused by chemical action. Generally, corrosion is caused by low <b>pH</b> or by water with levels of <b>TA, CH, pH</b> or sanitizer which are outside the recommended ranges.</p>
<b>Dichlor</b>	<p>Also called sodium dichlor. It is a type of chlorine and is frequently used when <b>shocking the water</b>. An effective <b>chlorine</b>-based powdered <b>oxidizer</b> and <b>sanitizer</b>. Dichlor works by oxidizing waste product in the water such as <b>bromamines</b> and <b>chloramines</b> and causing them to burn off.</p>
<b>Monopersulphate or MPS</b>	<p>Frequently used when <b>shocking the water</b>. An effective non-chlorine-based powdered <b>oxidizer</b> that works well with both <b>chlorine</b> and <b>bromine</b>. It works by oxidizing waste product in the water such as <b>bromamines</b> and <b>chloramines</b> and causing them to burn off.</p>
<b>Oxidizer</b>	<p><b>Shocking the water</b> with an oxidizing chemical prevents the buildup of contaminants, maximizes <b>sanitizer</b> efficiency, minimizes combined <b>chlorine</b> and improves water clarity.</p>
<b>Ozone</b>	<p>Ozone is a powerful oxidizing agent which is produced in nature and artificially. Ozone forms no by-products of <b>chloramines</b> (ozone actually oxidizes chloramines) and will not alter the water's <b>pH</b>.</p>
<b>pH</b>	<p>The pH level is the measure of the balance between acidity and alkalinity. Low pH causes the water to be too acid, which will cause <b>corrosion</b>, whereas high pH causes the water to be too alkaline, which will cause <b>scaling</b>. See page     for testing for and balancing pH.</p>
<b>ppm</b>	<p>The abbreviation of "parts per million", the standard measurement of chemical concentration in water. Identical to mg/l (milligrams per liter).</p>
<b>Sanitizer</b>	<p>Sanitizer is a chemical added to the water to kill bacteria and viruses and keep the water clean. The two sanitizers we recommend are <b>chlorine</b> and <b>bromine</b></p>

**Scale**

Rough calcium-bearing deposits that can coat spa surfaces, heaters, plumbing lines and clog filters. Generally, scaling is caused by mineral content combined with high **pH**. Additionally, scale forms more readily at higher water temperatures.

**Shock**

Also called shocking the water, shock treatment, or superchlorination. Shocking the water is adding significant doses of **dichlor** or **MPS** to **oxidize** non-filterable organic waste and to remove **chloramines** and **bromamines**. Shock treatment breaks down organic waste contaminants which cause odor and cloudy water.

**Total Alkalinity**

Abbreviated as TA. Total alkalinity is the measure of the total levels of carbonates, bicarbonates, hydroxides, and other alkaline substances in the water. TA is important for **pH** control. If the TA is too low, the **pH** will fluctuate out of control, and if it is too high, the **pH** becomes difficult to stabilize.

**Trichlor**

Used as a pool **sanitizer**. NEVER use trichlor in a spa. Trichlor is extremely acidic and will lower the **pH**, causing corrosion to equipment. Using trichlor will void your warranty.

## Water Testing Methods

There are two testing methods to choose from:

Test strips are a convenient testing method commonly used by spa owners.



The reagent test kit is a method which provides a high level of accuracy but is more expensive and more difficult to use if not experienced with this testing method.



## Adding Chemicals to the Spa

**IMPORTANT:** All spa water chemicals, including MPS (Shock), chlorine, granulated pH increaser or decreaser, granulated total alkalinity increaser, calcium hardness increaser, liquid stain and scale inhibitor, and liquid de-foamer must always be added into or in front of the filter compartment while the primary jet is running for a minimum of 10 minutes.

1. - Fold back the cover.
2. - Press the Jets button or Jet 1 button (Touch devices, activate pump 1)
3. - Carefully measure the recommended amount of chemical and slowly pour it into the filter area. Use care not to splash chemicals on your hands, clothes, eyes, or spa surface/siding
4. - Close the spa cover

**Warning:** High sanitizer levels can cause discomfort to the user's eyes, lungs, and skin. Always allow the sanitizer level to fall into the recommended range before using the spa.

**IMPORTANT NOTE REGARDING SHOCK TREATMENT:** After administering shock to your spa, leave the cover open for a minimum of 20 minutes to allow the oxidizer gas to vent into the atmosphere. A high concentration of trapped oxidizer gas which may exist as a result of the shock treatment (not daily sanitation) may eventually cause discoloration or vinyl degradation to the bottom of the cover. This type of damage is considered chemical abuse and is not covered under the terms of the limited warranty.



# Balancing Water Chemistry Levels

Maintaining spa water chemistry can be tricky, especially since there are many methods of keeping your water clear and clean. Note: We do not recommend a specific brand of chemicals.

See a spa dealer for guidance and recommendations on spa chemicals and supplies needed, as water chemistry varies from region to region. Various chemicals often sold under brand names, but a spa dealer can advise you on generic chemicals that are often less expensive than proprietary brands.

## Balancing the Total Alkalinity (TA)

Total Alkalinity is a measure of the total levels of carbonates, bicarbonates, hydroxides, and other alkaline substances in the water. TA is referred to as the water's "pH Buffer". In other words, it's a measure of the ability of spa water to resist chemical changes in the pH level.

If the TA is too low, the pH level will fluctuate widely from high to low. Fluctuations in pH level can cause corrosion or scaling of the spa components. Low TA can be corrected by adding sodium carbonate (pH/Alkalinity Up).

If the total Alkalinity is too high, the pH level will tend to be high, and may be difficult to bring down. It can be lowered by using sodium bisulfate (pH/Alkalinity Down).

Once the TA is balanced, it normally remains stable, although the addition of more water with a high or low alkalinity will raise or lower the TA reading of the water.

When the Total Alkalinity is within the recommended range, proceed to the next step.

## Balancing the Calcium Hardness (CH)

Calcium Hardness is a measure of the total amount of dissolved calcium in the water. Calcium helps control the corrosive nature of spa water, that's why Calcium - low water (Soft Water) is not recommended. It is very corrosive to the equipment and can cause stains in the spa shell.

If the CH is too high (Hard Water) formation of scale on the spa shell & surface can result. You can use a generic calcium remover to remove hardness from water. CH can also be decreased by dilution (75% Hard water, 25% Soft water) will usually yield a reading within the correct range. If soft water is not available or practical for you, a stain and scale inhibitor should be added to the spa water, according to label instructions.

If the CH is too low, add CH Increaser.

Once the CH is balanced, it normally remains stable, although the addition of more water with a high or low calcium content will raise or lower the CH reading of the water.

When the CH is within the recommended range, proceed to the next step.

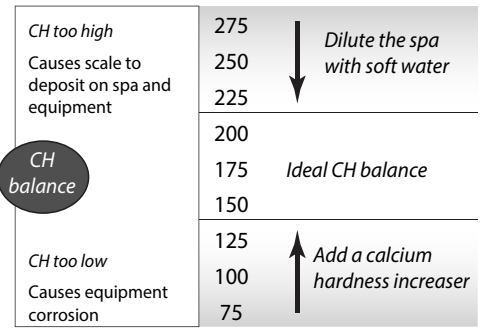
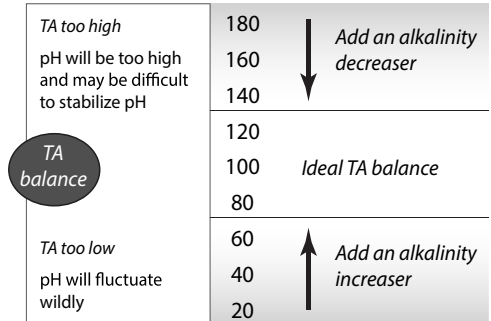

## Balancing the pH

The pH level is the measure of acidity and alkalinity. Values above 7.8 are alkaline; those below 7.2 are acidic. Maintaining the proper pH level is extremely important for optimizing the effectiveness of the sanitizer, maintaining water that is comfortable for the user, and preventing equipment deterioration.

If the spa water's pH level is too low, the following may result:

The sanitizer will dissipate rapidly

- The water may become irritating to spa users
- The spas equipment may corrode
- Bacteria and algae spikes can occur.

If the pH is too low it can be increased with sodium hydrogen carbonate (pH/Alkalinity Up) to the spa water.

If the pH level is too high, the following may result:

- The sanitizer is less effective
- Scale will form on the spa shell surface and equipment
- The water may become cloudy
- The filter cartridge may become obstructed.

If the pH is too high, it can be decreased by adding sodium bi-sulfate (pH/Alkalinity Down) to spa water.

**Note: After adding sodium hydrogen carbonate or sodium bi-sulfate, wait two hours before testing the spa water again for pH. Compounds take time to fully dissolve into the spa water, initial reading may not be accurate**

Its important to check the pH on a regular weekly basis. The pH will be affected by the bather load, the addition of new water, the addition of various chemicals, and other sanitizer used. When the pH is within the recommended range, proceed to begin the sanitation process.

pH too high Too alkaline, causes scaling	8.2	↓ Add a pH decreaser
	8.0	
	7.8	
pH balance	7.6	Ideal pH balance
	7.4	
	7.2	
	7.0	
	6.8	
pH too low Too acidic, causes corrosion	6.6	↑ Add a pH increaser

## Sanitation and Shock

Sanitizers kill bacteria and other organic waste by breaking them down to non-harmful level which are filtered out. Before you fill your spa, you need to decide which chemical sanitizer you wish to use. Consult your Cal Spas dealer for the right decision with regards to your lifestyle and spa usage.

**We recommend granulated chlorine or bromine as your sanitizer.** Both work well when maintained regularly

**Note: DO NOT USE Trichlor. Trichlor is very acidic and the hot temperature of the spa causes it to dissolve too fast, it will cause damage to your spa and will void your warranty.**

Whichever chemical you decide to use, do not take shortcuts. It will provide you with clean, safe, clear, spa water with a minimum of effort. Spa owners with an ozonator still need to use a chemical sanitizer. Whenever you test chemical levels, your test strip will likely have a test for chlorine or bromine. Make sure you sanitizer falls within the range shown on the next page.

Whenever you test your chemical levels, your test strip will likely have a test for chlorine or bromine. Make sure your sanitizer falls within the range shown on the next page.

**If your spa is equipped with a ozonator, this will assist in breaking down organic material and odors, but it will not disinfect your water, following the standard ppm recommendation for the sanitizer of choice is mandatory.**

## Starting & Maintaining Sanitizer Levels

*After you choose a sanitizer, you will need to establish a baseline and maintain it regularly.*

Sanitizing your spa with chlorine or bromine is very similar. Each sanitizer has its advantages and disadvantages. Sanitizer helps neutralize bacteria that can cause illness and other organic matter.

**Bromine:** Creates less odor and skin irritation than chlorine, bromine is less likely to do so. Additionally, unlike chlorine when bromine combines with bather waste and other contaminants in the water it remains an effective sanitizer. Bromine is also far less pH dependent than chlorine. Always remember that bromine itself is not a sanitizer, it needs to be activated with a bromine shock chemical in order to be effective, speak with your spa dealer for more information.

**Chlorine:** The most commonly recognized sanitizer is chlorine. However, the effectiveness of chlorine depends heavily on the pH level of the spa water. In order to get the most effective and economical benefit of chlorine, you must maintain a consistent pH level of between 7.2-7.6; a disadvantage of using chlorine is that when chlorine combines with bather waste and other contaminants, not only does it lose its sanitizing ability, it can cause odors and irritate eyes and skin to individuals with sensitive skin or prolonged spa exposure.

Testing For:	Ideal Range (ppm)	
	Minimum	Maximum
Chlorine Level	3.0 - 5.0	
Bromine Level	6.0 - 11.0	

***Note: If you choose to use bromine or chlorine we do not recommend the use of a floater. You have more control over the sanitizer levels by adding sanitizer as needed. Chemical abuse will void your warranty. When adding sanitizer to your spa, ensure that pump one is operating at high speed, and feed the sanitizer into the filter canister with the most suction, for spas with more than one pump we recommend activating all pumps for at least 10 minutes when adding sanitizer.***

Starting with fresh water/pre-filtered well water:

1. Establish a baseline by adding either granulated chlorine or bromine.
  - Use a half ounce of chlorine for every 500 gallons of water
  - Use half an ounce of bromine for every 100 gallons
2. Run the Jets for 10 minutes (Press/toggle the pump 1 button/icon)
3. Test the water, make sure the pH, TA, and CH levels all fall within the ranges shown in the previous pages, make adjustments as needed.
4. After balancing the water, if you are using bromine to sanitize your spa, you must activate your bromine. You will need to shock-oxidize the bromine inside of your spa. Depending on the size of your spa, usually you must add one to two ounces of shock, refer to the instructions inscribed in your chemical of choice.
5. Test the water again, when the water is balanced, your spa is ready to use.

## Shocking the Water

In addition to using a chemical sanitizer, you will periodically need to shock the water. Shocking the water helps remove burned-out chemicals, bacteria, and other organic material from your spa's water and improves your sanitizer's effectiveness.

Do not use chlorinating shock, which can damage the spas jets and pump seals. Only use Oxidizer shock. It can be used with either bromine or chlorine sanitizers.

Add two ounces of oxidizer shock per 500 gallons once a week, after heavy bather loads, or if the water has a strong odor. The spa must be running with all of the jets on high for 30 minutes with the cover open. If necessary repeat the oxidizer shock in 30 minute intervals.

## Filtration & Cleaning

The filter is the part of your spa that removes big and microscopic debris from the water to maximize your spas water clarity. Regular maintenance must be done to maximize the spas filtering performance and heat efficiency.

**It is extremely important that you never run the spa without a filter, there is a possibility that debris may be sucked into the plumbing, damaging the spa pumps and heater.**

## Cleaning the Filter

In addition to spraying the filter down with a hose to remove surface debris, the filter must be deep cleaned every so often to dissolve scale and particles that are trapped within the pleats of the filter. Even if the filter looks clean, scale and other particles hide deep within the filter fibers restricting water flow. If the filter is not properly cleaned this will cause flow issues within the spa heater creating a heater malfunction. We recommend cleaning your filter at least once a month or every two weeks depending on spa usage.

Cleaning the filter

1. Remove the filter by unscrewing the filter counterclockwise from the top of the filter, do not use excessive force when removing or installing the filter.
2. Place the dirty filter into a bucket of water where the filter is completely submerged in water. Add the desired filter cleaner of choice, on average most manufactures recommend 8 ounces of chemical cleaner, verify the amount used on your chemical instructions.

**Note: It is recommended to obtain a spare filter to use in the spa when performing maintenance on the dirty filters. This way you can rotate the filters and extend their lifespan.**

3. Soak the filter for a minimum of 24hrs
4. Spray the filter with a water hose, with careful attention between filter pleats.
5. Reinstall the filter, Do not over-tighten.



## General Water Care Schedule

<b>Prior to each use</b>	Test the spa water. Adjust chemical levels as necessary. Shock the water by adding ½ teaspoon of sodium dichlor per 250 gallons or 1 teaspoon of MPS per 250 gallons.
<b>After each use</b>	Add an ounce of oxidizer after heavy bather loads
<b>Once a week</b>	Check the filter well and inside the filter pipe for leaves and foreign matter. Test the spa water. Adjust chemical levels as necessary. Shock the water by adding ½ teaspoon of sodium per 250 gallons or 3 teaspoons of MPS per 250 gallons. If your water source is high in calcium, add stain and scale preventer.
<b>Every two to four weeks</b>	Deep clean your spa’s filter . How often you clean your filter depends on how much you use your spa. There is no harm in frequently cleaning your filter and will only help your spa’s efficiency.
<b>Every two to four months</b>	Change the spa water. How often you change the water depends on how much you use the spa. When you change the water, you will need to: <ul style="list-style-type: none"> <li>• Clean and polish the acrylic surface</li> <li>• Clean and treat the spa cover and pillows</li> <li>• Deep clean the filter</li> <li>• Refill your spa</li> </ul>
<b>Each time you refill the spa</b>	Follow the section “Filling and Powering Up Your Portable Spa”

## Generic Names for Chemicals

Water Chemistry		
Common name	Usual chemical name	Common brand names
pH Up	sodium hydroxide	pH Increaser, pH Up, pH Plus, pH Booster
pH Down	sodium bisulfate sodium bicarbonate (baking soda) sodium carbonate	pH Decreaser, pH Down, pH Minus, pH Subtractor, Dry Acid
Alkalinity increaser	sodium carbonate sodium bicarbonate (baking soda)	Alkalinity Increaser, Alkaline Up
Alkalinity decreaser	sodium bisulfate	Alkalinity Decreaser, Alkaline Down
Calcium increaser	calcium chloride	Calcium Increaser, Calcium Up, Calcium Plus, Hardness Increaser
Calcium decreaser	N/A To decrease calcium hardness, drain several gallons of water from the spa and refill using a mixture of 75% hard water and 25% soft water, or use a stain and scale inhibitor.	

**Sanitizers**

Common name	Usual chemical name	Common brand names
Chlorine	sodium dichlor	Both chlorine and bromine are available under numerous brand names
Bromine	sodium bromide	

**Shock**

Common name	Usual chemical name	Common brand names
MPS	monopersulphate	MPS Shock, Oxy-Spa, SeaKlear
Dichlor	sodium dichlor	Dichlor Shock

**Note:** Dichlor (chlorine) is both a sanitizer and a shock. Monopersulphate (MPS), when used as a shock, can be purchased alone as non-chlorinated shock or combined with dichlor, which makes it significantly more effective than MPS alone.

**Other chemical additives**

Common name	Usual chemical name	Common brand names
Stain and scale inhibitor	These are usually proprietary chemical formulations and cannot be purchased as a single generic chemical.	Metal Stain Gone, Scale Inhibitor, Stain and Scale Preventer, Stain and Scale Defense
Foam inhibitor		Foam Gone, Foam Down, Defoamer
Clarifier		Water Brite, Spa Bright, Water Clarifier, Clear Water, Natural Clarifier, Brite & Clear

**Do NOT use these in your spa:**

- Sodium hypochlorite (household bleach)
- Trichlor

## Common Water Chemistry Questions

**Question :** Why is the use of a floater not recommended to sanitize my spa water?

**Answer:** We do not recommend the use of a floater for three reasons:

- The floater is unable to control the rate at which the sanitizer is dissolved into the water. When a floater is placed into a spa the sanitizer levels inside the spa can be extremely high. High sanitizer levels over a period of time will cause chemical burns and discolor the spa shell, jets, pillows, and spa cover underside. The use of floaters tends to lead to negligence of spa water sanitizer levels as well. Once the sanitizer is all dispensed and the floater is not checked daily, the low sanitizer level will allow viruses, algae and harmful bacteria like Legionella (Legionnaires disease) and E-Coli to grow.
- Floaters tend to stay in one area of the spa most of the time, causing this area to be exposed to extreme sanitizer levels. Most commonly a floater will become trapped near the filter weir or a seat, causing chemical damage to the section of the spa.
- The floater may allow small chunks or pieces of the concentrated sanitizer to fall out of its housing causing the chunks to settle at the bottom, causing pitting or chemical blisters to the spa shell. For this reason we advise you to use granulated chlorine or bromine as granulated sanitizers are designed for dissolve quickly inside of the spa with your jets activated. Chemical abuse is not covered under the terms of the limited warranty.

**Question :** When I open my spa, I smell chlorine. How to I get rid of the smell?

**Answer:** There are two types of chlorine in your spa. the first is "Free Chlorine" which is chlorine molecules that are available to sanitize your spa. This free chlorine does not have an odor. The second is chloramine, which is a byproduct of chlorine that has already been used/expended to sanitize. Chloramines generate the strong chlorine smell most spa owners experience. This can be eliminated by shocking your spa water, if you smell chlorine in the water, its time to shock.

**Question:** Why can't I fill my spa with soft water?

**Answer:** Soft water is essentially the same as regular water except in one regard that is important for spa chemistry and that is calcium levels. The calcium inside of the water has been replaced by sodium, which can be corrosive to heaters, pumps, and other plumbing equipment which will become expensive to replace. Calcium is needed for certain chemicals to properly function as well. Only use potable water that has not been treated with a water softener.

**Question:** I am concerned about the amount of chemicals my family is exposed to, do I really need to use as many chemicals in large amounts?

**Answer:** While there should be concern of over exposure to any chemical being unhealthy, spa chemicals when used correctly are designed to be effective and beneficial. In the case of spa water, the chemicals we recommend are important to protect the user from waterborne illness, including skin infections and disease causing pathogens, chemicals also help to prevent corrosion of spa components.

**Question:** Why isn't water chemistry damage (chemical abuse) covered under warranty?

**Answer:** The chemical levels and water quality of the water in the spa are directly under your control. With proper basic care the spa will provide many years of hot water relaxation. If you are unsure about water chemistry, reach out to your spa dealer.

## Do's and Dont's

- Do add chemicals slowly into the front of the filter compartment/weir with jet one operating for at least 10 minutes.
- Do use special care if using baking soda to clean either the interior or exterior plastic surfaces.
- DON'T use swimming pool muriatic acid to lower pH.
- Don't splash pH increaser additives on the siding.
- Don't Use compressed sanitizers, The use of bromine sticks or tablets in floaters may become trapped in a lounge or cooling seat, and in some cases sink to the bottom of the spa. This may cause discoloration or stress on the spa shell.
- Don't use a floater type sanitation system as a low or no maintenance solution to your spa maintenance. Floating dispensers can become trapped in one area and cause an over sanitation (or chemical burn) of the particular area, damaging acrylic, jets, and pillows. If the dispensers setting is too high, the higher concentration can also cause chemical burn damage throughout the spa. This kind of chemical damage can be done by both bromine and chlorine sanitizers.
- Don't use a sanitizer which was not designed for spas.
- Don't use household bleach (liquid sodium hyperchlorite).
- Don't broadcast or sprinkle the chemicals onto the water surface. This method can cause chemically induced blistering on the spa surface (chemical abuse).

## Bather Load

"Bather Load" is the term used to describe the number of people using a spa, combined with the length of usage, and the frequency of usage. All these factors have a great effect on the spa water. The higher the bather load, the more chemicals need to be added and a longer filtration time will be needed.

Recommendations are designed for spas with average bather load (3 to 4 people, 15 minutes of usage, three times a week at 100 degrees). If your bather load exceeds these guidelines, and you experience water quality problems, increase the amount of filtration first, (go to the next higher filtration number) then if water quality is still not adequate, consult the advice of your Cal Spas dealer for additional chemical or system recommendations. Be sure to give them your bather load information.

## Ozonator

The ozone generator releases ozone into the spa water. You will still need to test for chlorine/bromine and occasionally replenish it to return the sanitizer level back to baseline. **For spas without a circulation pump, "Pump 1" will run at low speed and the ozonator will run during filtration.**

The spa's control system is factory programmed with one filter cycle that will run in the evening, aligning with lower energy rates in that time slot. The time and duration of the filter cycle can be set according to your needs. In addition, a second filter cycle can be enabled. Filtration time may need to be increased with a heavy bather load.

Make sure water diverter valves are turned all the way to the left or right, and never left in the center position during filtration cycles. When the diverter valve is in the center position, there is not enough suction from the pump in order to inject ozone into the spa. The ozonator will generate ozone, but it would not be injected into the water effectively.

## Troubleshooting Water Clarity

Problem	Probable Causes	Possible Solutions
Cloudy Water	<ul style="list-style-type: none"> <li>• Dirty Filter</li> <li>• Excessive oils/ Organic matter</li> <li>• Improper sanitation</li> <li>• Suspended particles/organic matter</li> <li>• Overused or old water</li> </ul>	<ul style="list-style-type: none"> <li>• Clean filter</li> <li>• Shock spa with sanitizer</li> <li>• Add sanitizer</li> <li>• Adjust pH and/or alkalinity to recommended range</li> <li>• Run jet pump and clean filter</li> <li>• Drain and refill spa</li> </ul>
Water Odor	<ul style="list-style-type: none"> <li>• Excessive organics in water</li> <li>• Improper sanitation</li> <li>• Low pH</li> </ul>	<ul style="list-style-type: none"> <li>• Shock spa with sanitizer</li> <li>• Add sanitizer</li> <li>• Adjust pH to recommended range</li> </ul>
Musty Odor	<ul style="list-style-type: none"> <li>• Bacteria or algae growth</li> </ul>	<ul style="list-style-type: none"> <li>• Shock spa with sanitizer</li> <li>• Adjust pH to recommended range</li> </ul>



Problem	Probable Causes	Possible Solutions
Organic Buildup/ Scum Ring Around Spa	<ul style="list-style-type: none"> <li>Buildup of oils and dirt</li> </ul>	<ul style="list-style-type: none"> <li>Wipe off scum with clean rag - if severe, drain the spa, use a spa surface and tile cleaner to remove the scum and refill the spa</li> </ul>
Algae Growth	<ul style="list-style-type: none"> <li>High pH</li> <li>Low sanitizer level</li> </ul>	<ul style="list-style-type: none"> <li>Shock spa with sanitizer if problem is visible or persistent, drain, clean and refill the spa</li> </ul>
Eye Irritation	<ul style="list-style-type: none"> <li>Low pH</li> <li>Low sanitizer level</li> </ul>	<ul style="list-style-type: none"> <li>Adjust pH</li> <li>Shock spa with sanitizer and maintain sanitizer level</li> </ul>
Skin Irritation/ Rash	<ul style="list-style-type: none"> <li>Unsanitary water</li> <li>Free chlorine level above 5ppm</li> </ul>	<ul style="list-style-type: none"> <li>Shock spa with sanitizer and maintain sanitizer level</li> <li>Allow free chlorine level to drop below 5 ppm before spa use</li> </ul>
Stains	<ul style="list-style-type: none"> <li>Total alkalinity and/or pH is too low</li> <li>High iron or copper in source water</li> </ul>	<ul style="list-style-type: none"> <li>Adjust total alkalinity and/or pH</li> <li>Use a stain and scale inhibitor</li> </ul>
Scale	<ul style="list-style-type: none"> <li>High calcium content in water - total alkalinity and pH too high</li> </ul>	<ul style="list-style-type: none"> <li>Adjust total alkalinity and pH - If scale requires removal, drain the spa, scrub off the scale, refill the spa and balance water</li> <li>Use a stain and scale inhibitor</li> </ul>

## Chemical Abuse

Chemical abuse is defined as negligent/careless use of both recommended spa chemicals, and use of prohibited chemicals. The spa shell is designed to last for many years, but when the shell is exposed to excessive chemicals, or improper chemical application; this can cause reactions on the shell that can cause pitting, cracks, bubbling, and other blemishes on the shell.

Spa jets, pillows, and other components are designed to withstand sanitizer levels within the range mentioned in this manual. Excessive sanitizer use will cause oxidation of the interior of the spas metals and other components, which can cause rust/oxidation of jets, deterioration of spa pillows, speakers and plastics, and damage/oxidation of the spa cover.

Components & materials damaged by chemical abuse are not covered under warranty. Depending on the extent of damage the entire spa warranty can be voided, as stated in the limited warranty.

## Cleaning and Maintenance

### Removing and Re-seating Pillows

You can remove the pillows for cleaning and maintenance quickly and easily. This method works for all pillow types.

Grab the lower edge of the pillow with both hands and firmly pull up, as you do this the pillow inserts will pop out of the holes.

Re-seat the pillows by aligning the pillow inserts with the holes and striking the pillow hard enough for the insert pegs to pop back in place.



### Jet Removal and Replacement

Jets can be easily removed for cleaning.

Grasp the outer lip/rip of the jet and turn it counter-clockwise until it completely stops, you may feel the jet loosen and pop out a bit, pull the jet outward. The jet will be very snug and may require additional turning force to pop-out. **DO NOT PRY OUT JETS**

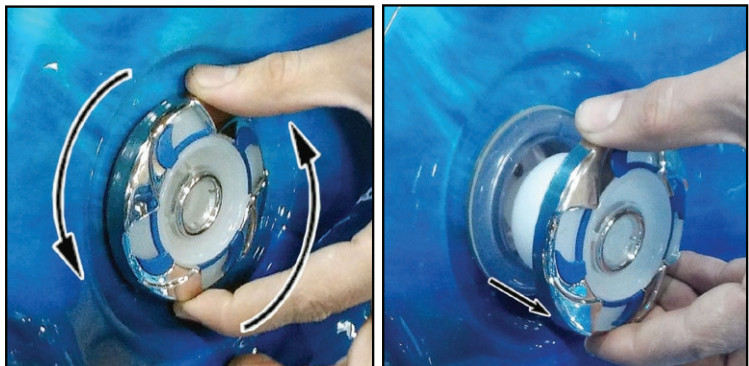

To replace the jet, place it in the fitting and turn clockwise until it click into place and can be rotated freely to open and close water flow again.

*Note: have the jets turned off when removing jet inserts, it will be easier to remove when there is no water flow through it.*

## Cleaning the Hydrostreamers

To ensure proper flow through the hydrostreamers, follow this maintenance process should any jet(s) have diminished flow.

**Step 1.** Turn the jet counter-clockwise to remove the chrome jet head.

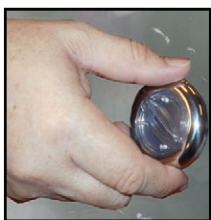

**Step 2.** Pull the chrome cap off.



**Step 3.** Pull the plastic jet opening and its gasket off.



**Step 4.** Pull out the inner plastic filter.



**Step 4.(2)** The plastic filter is shown completely removed from its housing

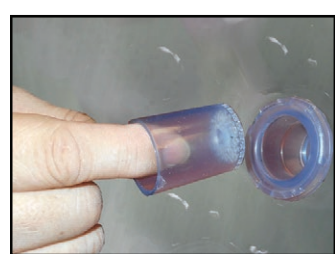

**Step 5.** Tap the filter and/or blow out the debris to ensure all holes are clear.



**Step 6.** Slide the plastic filter back in the Jet.

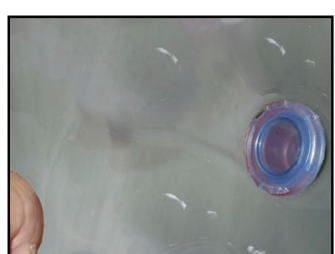

**Step 7.** Re-insert the gasket into clear plastic spout.



**Step 8.** Place the gasket into the plastic spout and then insert the spout into the jet body.

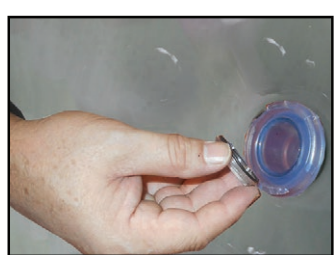

**Step 9.** Insert the plastic spout into the jet body.



**Step 10.** Place the chrome ring cap back on and turn clockwise to tighten it down.

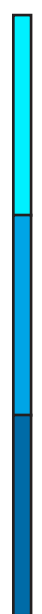
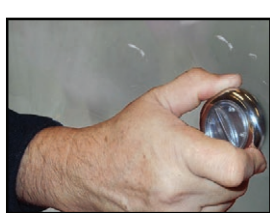





The spa cover can be considered one of the most important parts of your spa. The spa cover helps retain the heat inside of your spa in all different types of weather. The cover works as a lid on a thermos, when the spa is not in use the cover helps lower the amount of time the spas heater has to run for. Using the cover will help lower your operating cost of your spa when the spa is not in use.

**Note: The cover is constructed of rigid foam and metal, but it is not meant to support weight for your safety, do not sit, stand, or lie on the cover, nor should you place objects on top of the spa cover**

- Covered spas will protect your spas finish from the suns ultraviolet rays.
- You are required to use the spa cover to maintain warranty coverage.
- Covering your spa prevents children or pets from drowning in your spa.

**Step 1** Place cover on spa. Make sure it is correctly positioned, with the skirt of the cover wrapping over your spa shell. This helps prevent blistering and cracking from sun exposure.



**Step 2** Position the tie-down hardware (attached to the straps of your cover) on the side of the spa so they are easily reached by the cover tie-down straps.



**Step 3** With the straps pulled tight (but not overly tight), lightly pre-drill the location for screw placement. Gently drill 3 holes - one for each screw slot in the lock.

**Note:** Use a low torque drill, or use the lowest setting on your drill, do not drill in the screw all the way as the corners are designed with an air pocket inside to retain heat inside of your spa. Too much force lay deform the shape of the corner and would not look as appealing.

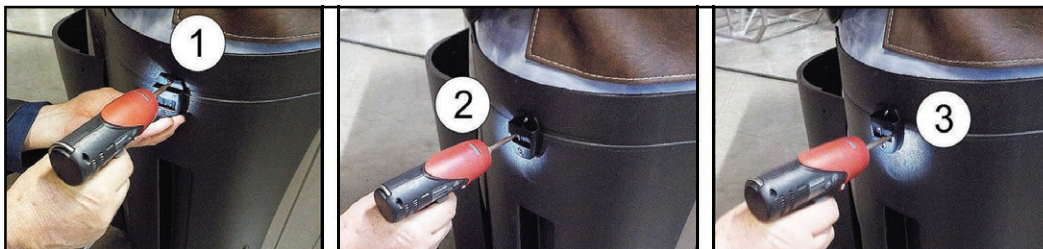

**Note: Illustrated corners may appear differently to the ones on your spa.**



**Step 4** Use a screwdriver to finish screwing in the three screws, repeat this process for the remaining 3 corners.



**Step 5** Keep the cover fastened down at all times when not in use, locking hardware may be locked with a key (provided in the packaging of the spa cover)



**Step 6** The provided key will allow you to lock down your spa cover. We recommend locking your spa cover when the spa is not in use. Store your key somewhere safe, away from children.



**WARNING**  
**AVOID**  
**DROWNING**  
**RISK**

**FAILURE TO FOLLOW INSTRUCTIONS MAY RESULT IN INJURY OR DROWNING  
NON-SECURED OR IMPROPERLY SECURED COVERS ARE A HAZARD.  
REMOVE COVER COMPLETELY BEFORE ENTRY OF BATHERS.  
ENTRAPMENT POSSIBLE.  
KEEP COVER ON SPA AND LOCKED WHEN NOT IN USE**

Your spa should be drained every four to six months for cleaning and maintenance and refilled with fresh tap water. Before you begin turn the power off to the spa at the breaker and remove your filters.

### Step 1. Locate Your Drain

Pull the knob out of the cabinet. The cabinet drain is screwed into the drain pull knob.



### Step 2. Remove the cap

Make sure the valve is in the closed position, then unscrew and remove the cap.



### Step 3. Connect Valve to a Hose

Attach a garden hose to the hose-bib fixture. Place the other end of the garden hose where you would like the water to drain to.

### Step 4. Drain the Spa

Turn the valve on the hose-bib fixture to open the drain. When the spa has drained completely, turn the valve on the hose-bib fixture, remove the hose and replace the cap.

## Winterizing (Cold Climate Draining)

Depending on your region in your country, the temperature could drop below 32F(0°C). If you are one of those regions, we recommend that you always have your spa full of water and running at normal spa temperatures between 80°F - 100°F (26.7°C - 37.8°C). This will help reduce the risk of water freezing in your spa and inside of the spa equipment.

**WARNING: If you find the need to drain your spa, be aware of the potential risk of water freezing in your spas equipment and plumbing, even if the directions below are followed perfectly, there is no guarantee that your spa will not suffer freeze damage. Freeze damage is not covered under warranty.**

- 1 - Open all filter covers.
- 2 - Remove the filter baskets and filters
- 3 - Drain your spa completely.
- 4 - Vacuum water from the spa's main drain fitting with a wet/dry vacuum
- 5 - Open the bleeder valves on the pumps
- 6 - For spas equipped with a UV light, loosen the quarts tube nut to let the water drain from the UV light chamber.
- 7 - Disconnect the unions from both sides of the pump.
- 8 - Blow out any remaining water out of the jets, suction, filter canister, and equipment area with a wet/dry shop vac.
- 9 - When it has completely finished draining, replace the quarts tube in the UV lamp chamber, and tighten the nut. Close the bleeder valves and re-connect the unions on the pumps.
- 10 - Replace the filter basket and filters.
- 11 - Cover your spa with a good spa cover and an all weather tarp to ensure neither rain nor snow enters the spa.



**Note: Do not use antifreeze to treat your spa, irreversible damage will occur to seals and spa finish.**

## Cleaning and Replacing the Filter

Filtration is one of the most important steps you can take to ensure clean, clear water. It is far less expensive to fix water clarity problems by properly filtering your spa than using excessive amounts of chemicals, excessive filtration times, or by water replacement.

## Vacation Care

You can leave your spa unattended for up to two weeks if you follow these instructions

**Note: Always lock your spa cover using the cover locks if you plan to be away from home and the spa is filled with water, these instructions will help maintain your water quality for up to two weeks. Use of the spa during this period of time by guests or family can affect the clarity and conditions of the spa.**

Select a low range temperature of 80F (27C)

*Note: Platinum Spas & Escape Spas with Gecko systems, Refer to filtration mode "Away From Home"*

1. Use a test strip, Adjust pH, AK, and CH if necessary.
2. Shock the spa water with your selected sanitizer (Add either bromine or chlorine)
3. Lock the spa cover to the cover locks.
4. When you return, test the water again and adjust pH and shock the water again.

If you will not be using your spa for longer than 14 days and the spa is not able to be maintained, we recommend following the cold climate procedure to prevent algae growth, bacteria, and spa damage.

### Spa Cover and Pillows

Due to constant punishment your spa cover and pillow receive, you should protect them by applying a vinyl and leather cleaner as part of your monthly maintenance plan. Use a product that is designed specific to spa covers and pillows, to protect them from UV ray damage without leaving an oily residue. Contact your spa dealer for recommendations.

**Warning DO NOT use any kind of automotive vinyl protectants on spa pillows or covers (ex. Armor all, Meguiar's, etc). These products are oil based and will leave an oily layer on your water line and will cause severe water clarity issues that require hours of work to correct, including multiple flushes of the system.**

### Spa Shell

Each time the spa is drained, before the spa is refilled it should be cleaned with an all purpose cleaner, or a mild detergent, followed up with a surface protectant. Do not use abrasive chemicals or cleaning tools as it may scratch the acrylic. Use a non oil based protectant designed for spas to protect the finish from mineral build up associated with normal spa use.

## Using the Freedom Sound System

The Freedom Sound System™ entertainment option contains a Bluetooth enabled speaker system that is available for certain Cal Spa models. Any Bluetooth-enabled device can be used to play audio through your spa. Before you can use the sound system, you will need to pair the speakers to your smart device via Bluetooth. The Freedom Sound System will respond to equalizer (EQ) from your mobile device, use your devices settings to adjust bass, treble, or certain frequencies you wish to amplify.

On your mobile device, open the settings and select Bluetooth, the device will begin to scan for available devices. Bluetooth signal is the strongest when you are next to the spa with a range of 5-10 feet based on conditions and the position of the spa.

**The sound system will appear as "Aquatic AV" on your mobile device.** Apple devices may require a password to pair , use "0000" to pair the spa to your device. Android devices will pair at initial selection from your devices Bluetooth menu.

Once your device is paired and connected, all sounds from your device will be played through the sound system, including system sounds and telephone.

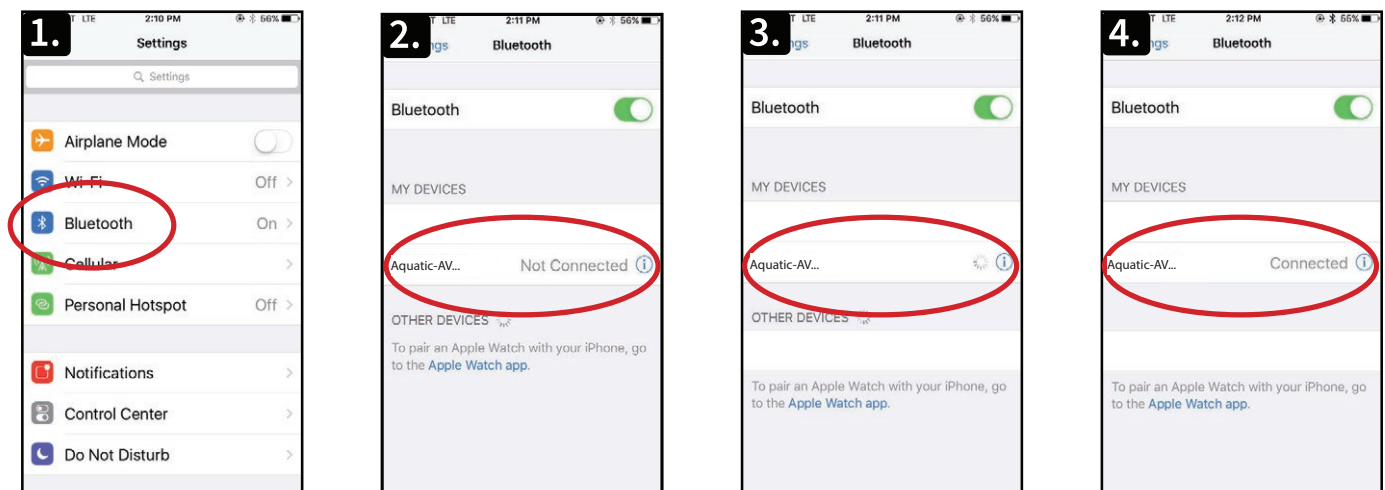

This Page is Intentionally Blank



### Air Injection/Resistance

Use the control panel to start and stop jets, and use the air venturis at the end of the spa next to the main hand rail of the spa to inject air into the swim jets. Although the FA1325 is not designed as a fitness spa, the swim jets installed in this spa will allow users to do moderate swimming exercises. When air is introduced to the spa jets, water resistance increases, giving you the ability to control your swimming resistance. You may also adjust the angle of the main swim jets to push water upward or lower to increase buoyancy and resistance.

### Swim Tether

Although the FA1325 is not a dedicated fitness spa, the spa is equipped with a swim tether base, and anchor points for fitness equipment. The swim tether pole has three pieces and assembles easily. slide the ends of the top and middle sections into the middle and bottom sections.

Insert the tether in the anchor hole when you are read to use it. Buckle the strap around your waist, it is easily adjustable and can accommodate most sizes as its designed as a one fits most.

### Exercise Equipment

#### Optional Add on Item\*\*

**Important:** Always consult your physician before starting any exercise activity or fitness program, the exercise equipment is designed for resistance training using elastic bands. When these bands are stretched the bands are under high tension. Improper use or failure to connect the exercise equipment can lead to injury, under high tension these bands can snap back towards the user or to others in or near the spa. Always inspect all of the exercise equipment and their connections before beginning any exercise. Never use any damaged equipment, and only use this equipment for its intended purpose.

### Connecting the Exercise Equipment

The drawings starting on page 57 show the exercise kits placement in different spa models. Refer to the following pages to learn where the proper anchor points are within your swim spa.

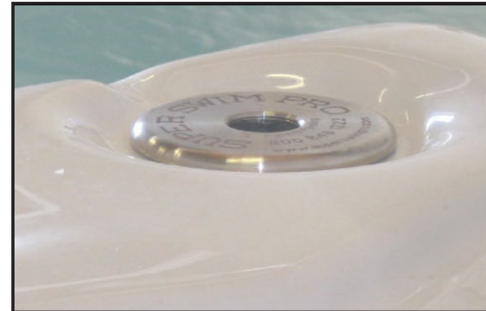
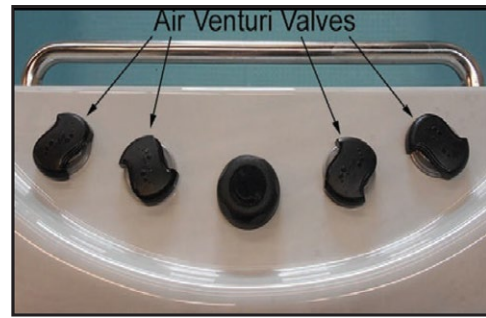

#### For 14 foot spas including F1325, X

The exercise kit contains

- Two hand grips
- Two 6" elastic bands
- Two 18" elastic bands
- Two 25" elastic bands
- Two rowing bars

#### For 16 and 17 foot spas

The exercise kit contains

- Two hand grips
- Two 18" elastic bands
- Two 25" elastic bands
- Two 56" elastic bands
- Two rowing bars.

## Anchor Points for Fitness Straps

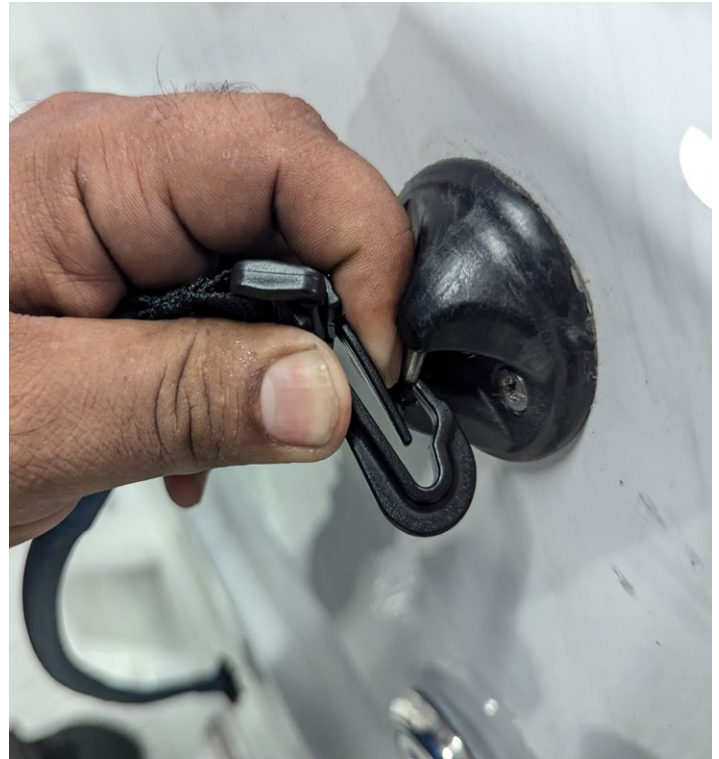

There are several different anchor points within your Family Fun Spa. These anchor points can be used to install fitness equipment including the row bars and fitness straps. All equipment within the fitness equipment pack uses plastic clips or metal hooks

Swim spas are not included with fitness equipment, this is an add on accessory. You can purchase this equipment from your dealer, or from our website at [www.quickspaparts.com](http://www.quickspaparts.com).



**Note:** When attaching the row bar align the row bar to hook towards the front of the spa. These row bars slide onto the anchor point by lining up the row bar into the anchor, hook and slide it.

Hook the row bar with caution to avoid scratching the acrylic within your spa.

**Note:** When the fitness equipment is not in use, do not leave the elastic straps/bands, handles, or row bars inside of the spa. After each use dry the equipment with a towel and store within its provided duffel bag.



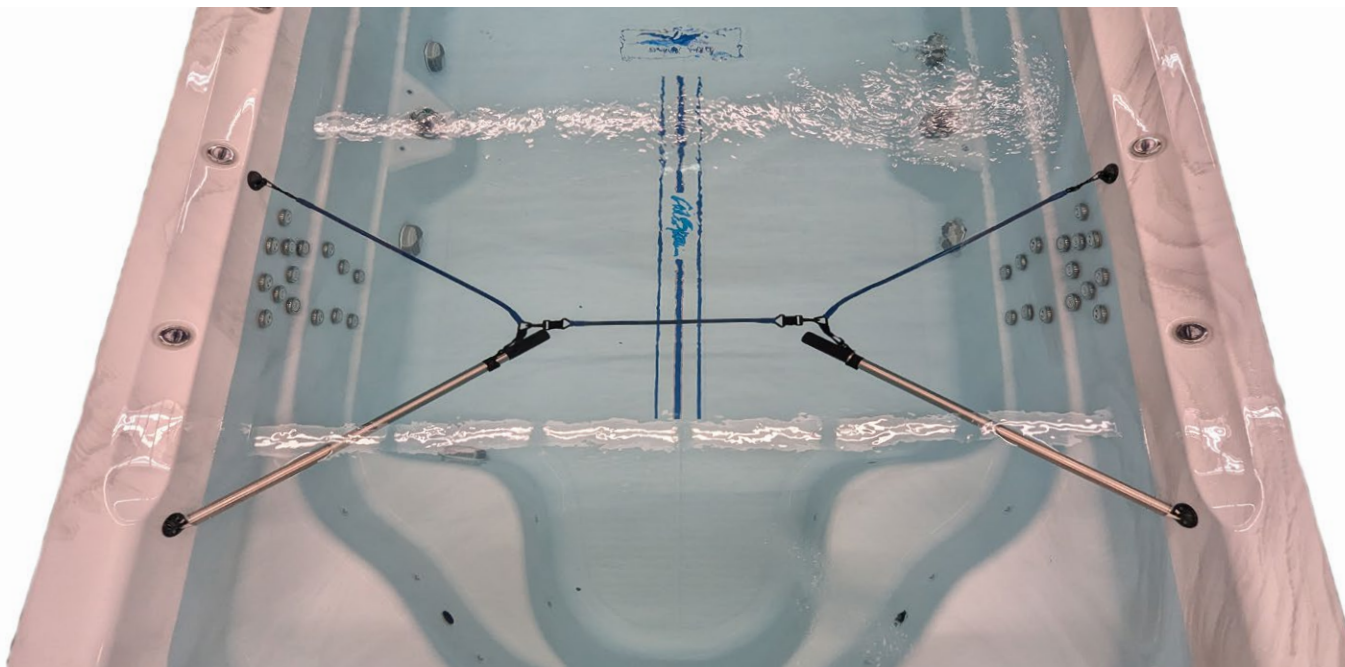

*For illustration purposes only\**

**Refer to page 59 for proper placement of exercise straps/equipment**

The Fitness straps should be used to secure the row equipment in place. First secure the row itself with an anchor point, a 25" strap will be used on each side. The smallest 18" strap should be used to connect the two rows together.

**Note: Always be cautious when setting up the fitness equipment, the straps have tension once they are set in the row position, and have tension when used to do other warm up exercises.**



The kit is designed to do a variety of different stretches and exercises. The Family Fun Spa has multiple anchor points that can be used to suit a variety of desired exercises.

**Note: Always proceed with caution when using elastic bands, improper operation can snap the bands and cause damage to the spa or personal injury.**

# Anchor Points for Fitness Equipment

The diagrams below show where each of the anchor points are. Each point is circled within the diagram. These diagrams also show the expected position of each strap style

**Note:** The center anchor point is not circled. This is meant for a swim tether.

## F-1325X



= Anchor Point

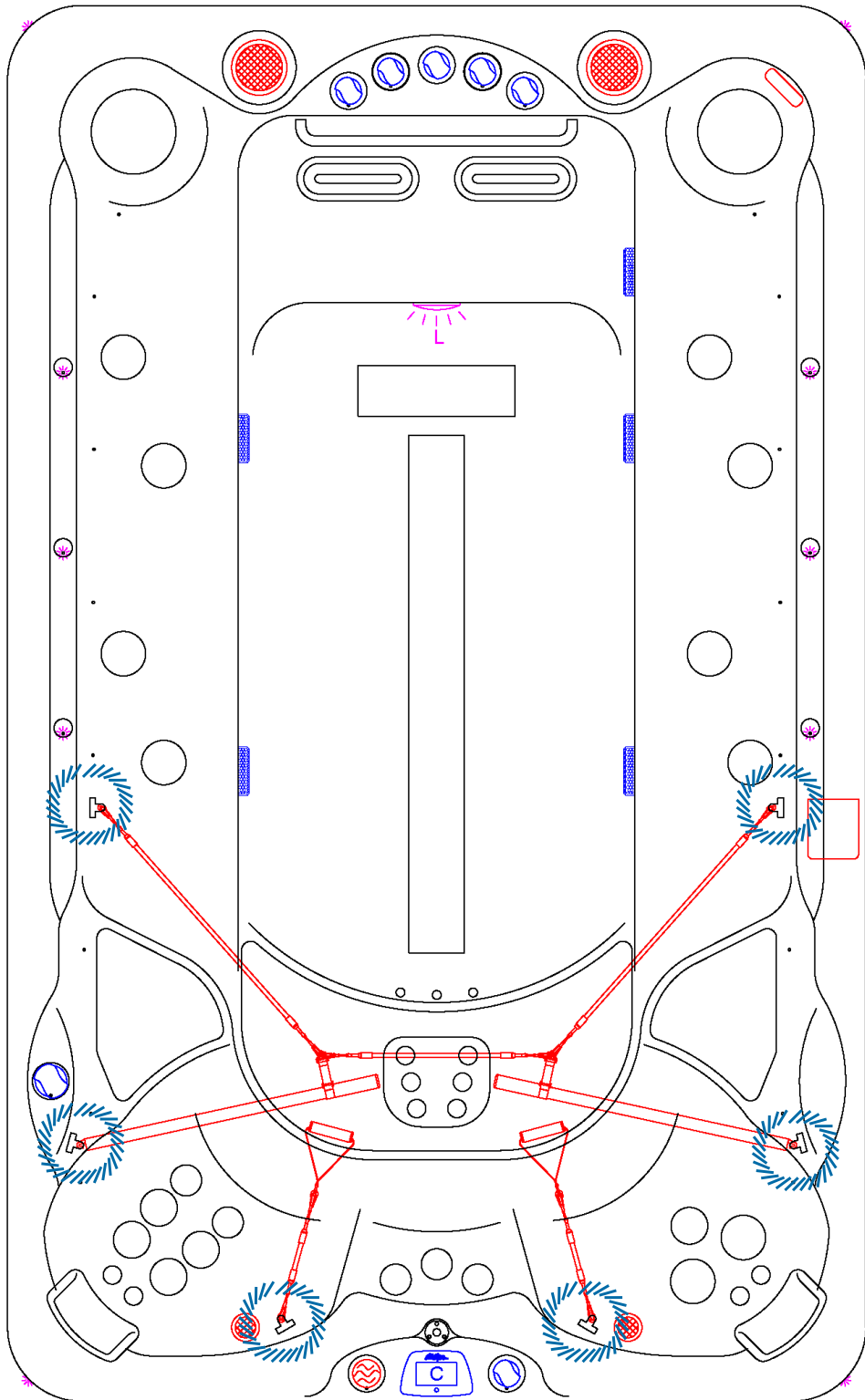

This Page is Intentionally Blank

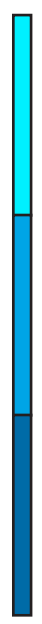



This Page is Intentionally Blank



## Replacement Parts

### Jet Inserts - Screw-in

**ELE 2" Euro No Eyeball**

PLUCS2295021S

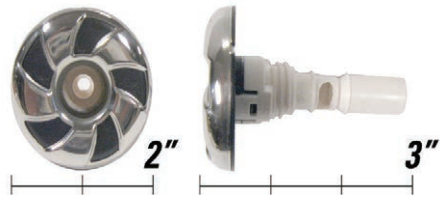

**MED 3" XL Cluster Storm Directional**

PLUCS2295031SL

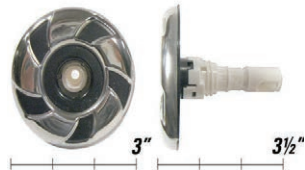

**mfd 3" Micro Flow Directional**

PLUCS2295061SL



**MM 3" Mini Storm Massage**

PLUCS2297061SL-8

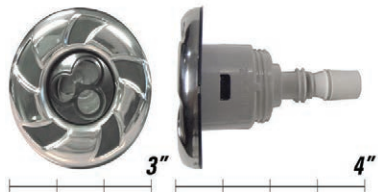

### Jet Inserts - Screw-in

**MFD 3.5" Maxi Flow Directional**

PLUCS2295091SL

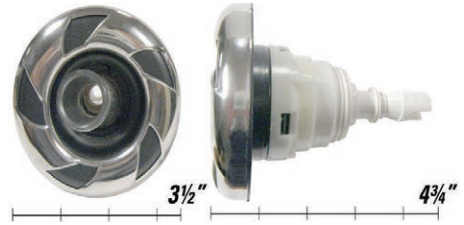

**PSD 5" Power Storm**

PLUCS2295131SL

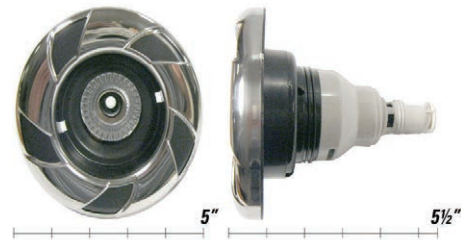

**PSR 5" Power Storm Riffed**

PLUCS2295141SL

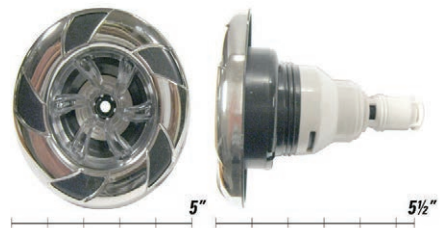

**PST 5" Power Storm Wagon Wheel**

PLUCS2295191SL

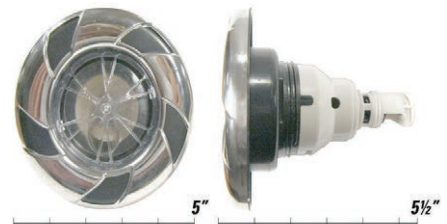

## POWER JETS

**Part #** CS2444009SSCDHL  
Pwr. Storm Internal, Metal  
Directional Eyeball, Velocity  
Esc., CDG/HLG

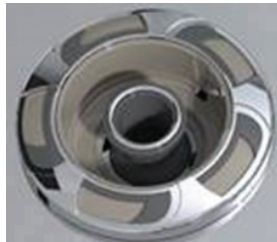

**Part #** CS2444049S-CDHL  
Power Storm Internal, Twister,  
Velocity Esc. – CDG/HLG



**Part #** CS2444019S-CDHL  
Pwr. Storm Int. Cal Spas Tri  
Directional Eyeball, Velocity  
Esc., Metal CDG/HLG



**Part #** CS2444059S-CDHL  
Power Storm Internal,  
Multi-Massage, Velocity Esc.,  
Metal – CDG/HLG



## WHIRLPOOL JETS

**Part #** CS2394009S-CDHL  
Adjustable Whirlpool Internal,  
Velocity Esc., Metal – CDG / HLG

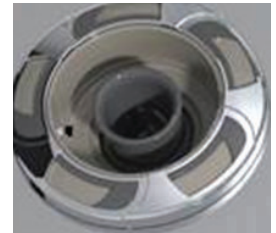

### CLUSTER JETS

**Part #** CS2441009S-CDHL  
 Cluster Storm Internal, Directional,  
 Velocity Esc., Metal – CDG/HLG



**Part #** S2442059S-CDHL  
 Mini Storm Internal, Multi-Massage,  
 Velocity Esc., Metal – CDG/HLG



**Part #** CS2441029S-CDHL  
 Cluster Storm Internal, Twin,  
 Velocity Esc., Metal – CDG/HLG



### POLY JETS

**Part #** CS2443009SSCDHL  
 Poly Storm Internal, Metal  
 Directional Eyeball, Velocity  
 Esc., -CDG/HLG



### MINI JETS

**Part #** CS2442009SSCDHL  
 Mini Storm Internal, Metal  
 Directional Eyeball, Velocity  
 Esc., Metal CDG/HLG



**Part #** CS2443029SSCDHL  
 Poly Storm Internal, **Metal Roto  
 Eyeball**, Velocity Esc., Metal  
 CDG/HLG



**Part #** CS2442049S-CDHL  
 Mini Storm Internal, Twister,  
 Escape, Velocity Esc. – CDG/HLG



### Water Diverter Valves

**Diverter Valve 2" Titanium Black (CS600303T1-TT)**  
PLU21300465



**Diverter Valve 1" Titanium Black (CS600426T1-TT)**  
PLU21300453



**Diverter Valve 1½" On/Off ASSY (600-4601)**  
PLU21100045



### Air Control Valve

**Air Control with Titanium Black CS660350T1-TT**  
PLU21300504



### Drains

**Drain Super Hi Flo Suction 2½" Black (640-3581LGV)**  
PLU21400146



**Low Profile Drain ¾" Black (640-0511)**  
PLU21400401



### PILLOWS

**Black "Y" Pillow Carbon Fiber Design S-01-4324**  
ACC01401102



### JET INSERTS (Updates)

**Swim Jet Rip Current Metal DSG/clear w/ Load Washer**  
PLU21051685DSG



**Power Stream Swim Jet**  
PLU210-0821S





### Teleweir Skimmer

50 square foot teleweir skimmer:  
ft. (510-4601)  
FIL11700006



**DYNA-FLO PLUS FILTER, 75SF 2"CKV  
4SCLP; HIGH VOLUME; LESS CARTRIDGE**

**Part #** FIL510-9559-CDCL

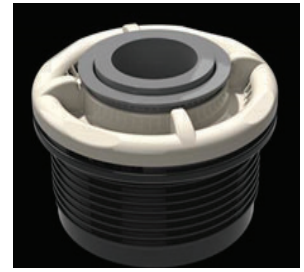

### Filters

50 sq ft female threaded -  
antibacterial for Teleweir  
skimmer shown above)  
FIL11100208

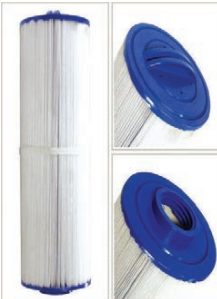

**TELEWEIR FILTER, 50SF 2"CKV  
6SCLP LESS CARTRIDGE  
2-TONE CDG/HLG**

**Part #** FIL510-4609-CDCL



### SUCTION

**Part #** 644-5419CDHL V  
5"DESIGNER PRO-SUCT. ASSY. 2.5"S  
2-TONE, ELL GASK. (EPDM 50 SHORE) &  
LOAD WASHER

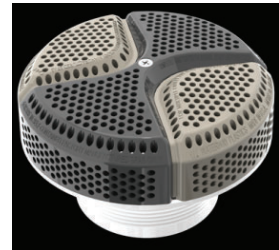

**LED Lights**

1-LED light string  
Part #: LIT16100330



2-LED light string  
Part #: LIT16100331



4-LED light string  
Part #: LIT16100332



1 to 3 ext. cord  
LIT16100335



1 to 1 port ext. cord  
LIT16100338



Interior light with logic (7 LED)  
LIT16100333



Interior light without logic (7 LED)  
LIT16100337



Main light housing, LED lens, fitting nut  
LIT630-7048



**AIR CONTROL**

**Part # CS6603709-CDHL**  
"Cal Spas 1" Air Control Complete  
Assembly, Velocity Style, CDG/HLG"

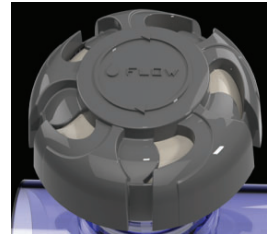

**Part # PLUCS6054309-CDCL**  
"Cal Spas 1" Air Control Complete  
Assembly, Velocity Style, CDG/HLG"



**Part # CS6053309-CDHL**  
"Cal Spas 2" Top Access  
Diverter Valve Sub-Assembly,  
Velocity Style, CDG/HLG"

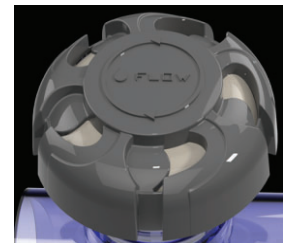

### Cover Lock and Keys

Part #: ACC01800026



### Replacement of Cabinet Panels

The complete selection of replacement cabinets for all models is very extensive and too lengthy for this owner's manual. To order replacement panels for your spa, visit [www.quickspaparts.com](http://www.quickspaparts.com)

### Covers

All spa covers are designed with a tapered height, angling downward from the center to the sides to drive off rain and prevent water from pooling. The covers listed below are filled with either 1 lb, 1.5 lb, or 2.0 lb foam.

#### Deluxe

5" - 3"  
2.0 Lb. foam



#### 93" x 141"

Fits spa models: F-1222

- COV93141DBK-3 Deluxe Taper Black
- COV93141DDB-3 Deluxe Taper Dark Brown
- COV93141DG-3 Deluxe Taper Gray

#### 93" x 171"

Fits spa models: F-1420, F-1437

- COV93171DBK-3 Deluxe Taper Black
- COV93171DDB-3 Deluxe Taper Dark Brown
- COV93171DG-3 Deluxe Taper Gray

#### 93" x 200"

Fits spa models: F-1640, F-1770

- COV93200DBK-3 Deluxe Taper Black
- COV93200DDB-3 Deluxe Taper Dark Brown
- COV93200DG-3 Deluxe Taper Gray

#### 93" x 210"

Fits spa model F-1896DL

- COV93210DBK-3 Deluxe Taper Black
- COV93210DDB-3 Deluxe Taper Dark Brown
- COV93210DG-3 Deluxe Taper Gray

#### 93" x 151"

Fits spa model F-1335

- COV93151DBK-3 Deluxe Taper Black
- COV93151DDB-3 Deluxe Taper Dark Brown
- COV93151DG-3 Deluxe Taper Gray

This Page is Intentionally Blank

# Basic Troubleshooting

The troubleshooting guidance provided here is intended to cover the most common problems a spa owner may encounter. For more in-depth troubleshooting, go to [www.calspas.com/troubleshooting](http://www.calspas.com/troubleshooting).

Symptom	Possible Solutions
---------	--------------------

## Problems starting up

Pump won't prime	See priming instructions on page 14.
Breaker keeps shutting off	Reset the GFCI breaker. If this continues, contact your dealer or a qualified spa technician.

## Power and system problems

System won't start up or breaker keeps shutting off	Power may be shut off. Turn on GFCI circuit breaker. If this continues, contact your dealer or a qualified spa technician.
Control panel doesn't respond	Turn on or reset the GFCI circuit breaker. If this does not solve the problem, contact your dealer or a qualified spa technician. If you hear the pump running but the control panel doesn't respond, contact your dealer
Spa does not turn off	Spa may be trying to heat up. Check if spa is in Ready or Rest mode (see page 26) In cold climates, if spa is not equipped with full foam or any kind of insulation, it will try to maintain the set temperature. Set the spa to low temperature range and set the temperature to 80°F. Spa may be in filter cycle. If it is, this is normal and no adjustment is necessary.
Message on the control panel	There may be a problem. See Diagnostic Messages on page 58.

## Heat problems

Spa water does not get hot	Spa may be in low temperature range. Set the spa to high temperature range. The filter may be dirty or may need to be replaced. Clean or replace the filter. The water level may be too low. Fill the spa with water level at 4 to 6 inches from the top. The temperature is not turned up high enough. Raise temperature on topside control. Cover the spa. The cover will keep heat in the spa and help keep heat from escaping. Make sure cover is on at all times when spa is not in use. The heater element may be old, deteriorated, coated with scale, or defective. Contact your dealer for more assistance. The gate valves may be partially or completely closed. NEVER OPERATE YOUR SPA WITH THE GATE VALVES CLOSED!
----------------------------	---





**Symptom****Possible Solutions**

Spa overheats - temperature greater than 110°F / 43°C

Overheating can occur during summer months and may not necessarily indicate a malfunction. When it occurs, a message code may also appear on the control panel.

Temperature may be set too high. Turn the set temperature down to a lower temperature.

Filtration time may be too long. Turn the filtration cycles down during the warm months.

The spa may not be properly ventilated. Make sure the front of the spa is not blocked to allow air flow.

High speed pumps may have been running too long. Limit pump running time to no more than 15 to 30 minutes.

**Water pressure problems**

Low water pressure

Jet valves may be partially or fully closed. Open the jet valves.

Filter cartridge may be dirty. Clean or replace the filter.

Pump may have airlock. Remove airlock by priming spa (page 14)

The suction fittings may be blocked. Remove any debris that may be blocking them.

The filter skimmer may be blocked. Remove the blockage.

Gate valves may be closed. Open gate valves. Note: Never operate your spa with the gate valves closed!

Spa may be running in filtration mode. Press JETS or JETS 1 button to turn on high speed pump.

No water pressure (no water stream from any jets)

Power may be switched off. Turn the power back on.

The pump may be defective. After you have tried all other troubleshooting, contact your dealer for assistance.

Jets surge on and off

Water level may be too low. Add water to normal level.

**Pump problems**

Pump runs constantly – will not shut off

There may be a problem with circuit board. Contact your dealer.

Noisy pump

The water level may be too low. Fill the spa with water level at 4 to 6 inches from the top.

Filter cartridge may be dirty. Clean or replace the filter.

Pump may have airlock. Remove airlock by priming spa (page 14)

The suction fittings may be blocked. Remove any debris that may be blocking the suction fittings.

Gate valves may be closed. Open gate valves. Note: Never operate your spa with the gate valves closed!

Air may be leaking into the suction line. Contact your dealer for assistance.

Debris may be inside the pump. Contact your dealer for assistance.

Noise may be a sign of damage. Contact your dealer for service.

Symptom	Possible Solutions
Pump turns off during operation	Automatic timer may have completed its cycle. Press JETS or JETS 1 button to start the cycle again. Pump may have overheated due to the vents on the equipment door being blocked. Make sure the front of the spa is not blocked to allow air flow. The pump motor may be defective. Contact your dealer for assistance.
Pump has a burning smell while running	A burning smell may be a sign of damage. Contact your dealer for service.
Pump does not run	Pump may have over heated. Let it cool for an hour and try operating the spa for a shorter time. Power to the spa may be shut off. Turn on or reset the GFCI circuit breaker. If this does not solve the problem, contact your dealer or a qualified spa technician.

## “Thermal Creep”

Cal Spas are designed with energy-efficient components and systems that are meant to sustain heat generated by the equipment, which is then cycled back into the spa water. In hot weather or in situations where the spa is set to extended run times, Thermal Creep may occur. Thermal Creep is a condition where the measured water temperature can be higher than the set temperature. To manage Thermal Creep you may:

**Vent your cover.** This means placing a folded cloth about ¾” (2cm) thick under all four corners of the cover before you lock the cover down.

**Open your cover.** Opening the cover at night will also quickly cool the water down if desired.

**Open all air controls.** Set your filtration cycles to run during the cooler times of the day or night.

**Reduce the length of your filter cycles.**

**Visit your local dealer for additional guidance.**

Since Thermal Creep only occurs in well-insulated hot tubs, it is not indicative of something that is wrong with your spa or its equipment.

This Page is Intentionally Blank

# LIMITED WARRANTY

This Limited Warranty is extended to the original purchaser of the spa produced by Lloyd's Material Supply company, Inc. Which Manufactures the Cal Spas brand portable spa manufactured after January 1st, 2025 and installed for residential use in the United States of America and Canada. This Warranty begins on the date of delivery of the spa, but in no event later than one year from the date of manufacture.

## Swim Spas

<b>Structural</b>	Warrantied against spa shell collapse, leaks caused by the shell, or dangers of structural integrity due to defects in the spa shell.	<b>10 Years</b>
<b>Shell Surface</b>	Warrantied against spontaneous blistering, cracking, or delaminating of the interior spa shell.	<b>7 Years</b>
<b>Equipment &amp; Controls</b>	Electrical Equipment- limited to spa pumps, standard heater, and control system/panels, are warrantied against malfunction due to defects in workmanship or materials.	<b>5 Years</b>
<b>Plumbing</b>	Warrantied against leaks/cracks due to defects in workmanship or materials	<b>5 Years</b>
<b>Spa Cabinet</b>	Warrantied against defects in workmanship or materials. Normal wear and weathering of the finish will occur naturally over time and are not defects.	<b>5 Years</b>
<b>Sanitation</b>	Salt cells & bromine generators are warrantied against defects in workmanship or materials, this includes sanitation control panels & electrical.	<b>1 Year</b>
<b>Ozone/UV</b>	Ozone Generators and UV treatment systems are warrantied against defects in workmanship and materials. (Excluding UV bulbs older than one year)	<b>2 Years</b>
<b>LED Lighting</b>	LED lights are warrantied against malfunction due to defects in workmanship and materials	<b>2 Years</b>
<b>Sound System</b>	The Freedom Sound System is warrantied against malfunction due to defects in workmanship and materials. This does not cover normal wear and tear.	<b>1 Year</b>
<b>Spa Cover</b>	The spa cover is warrantied against malfunction due to defects in workmanship and materials. This does not cover normal wear and tear.	<b>3 Years</b>

## Warranty for Other Components

The fuses, headrests, cal grip, labels, and filters are warrantied to be free of defects in workmanship and material at the time of delivery. All other factory-installed components not mentioned specifically, including, but not limited to the wood frame, jets, diverter valves, filter lids, and other mechanical components, are warrantied against malfunction due to defects in workmanship and material for two years from the original date of delivery. This warranty is void if the spa has endured neglect, chemical abuse, or use of unapproved chemicals or components.

## Structural

This limited warranty covers defects within the spas fiberglass structural shell. This includes sudden spa shell collapse, leaking through the shell, and separation between the spa shell and spa acrylic, caused by faulty bonding. This does not include separation due to micro-abrasions, pin holes in the shell, or warping/bubbling due to sun exposure. This limited warranty does not apply when abuse of the spa shell is evident. This includes but is not limited too, heavy impact craters, fractures on the spa surface due to poor spa care, sun exposure, or reckless use of the spa, and chemical abuse of the spa. This warranty does not cover damage caused by unlevelled ground. Spas must rest on level ground, ideally on a cement slab of 3-6" of thickness depending on the spa weight. Spas that are not placed on a leveled foundation are prone to cracks, delamination, and compromised structural rigidity of the spa. It is the responsibility of the spa owner to ensure that the spas foundation is leveled and inspected before placing the spa.

## Shell Surface

This limited warranty covers defects on the spas acrylic surface due to workmanship or materials. This covers wrinkles on the acrylic, blistering, peeling, delamination, or spontaneous cracking. This warranty does not cover shell damage caused by chemical abuse, improper water chemistry, excessive sun exposure, micro-abrasions, or damage caused by impacts or sharp objects. This warranty does not cover discoloration, or deterioration of the spa shell when exposed to improper chemistry levels, hard water, soft water, or chemical abuse.

## Equipment and Controls

This limited warranty covers malfunction of factory installed spa control systems, spa control panels, spa heater, and spa pumps due to defects in workmanship or materials. This covers sudden control box failure, malfunction of control panels or control boxes, malfunctioning heaters, and malfunctioning spa pumps. This warranty coverage is void if the electrical installation of the spa does not follow the outlined diagrams and specifications, mentioned in this manual. Failure to properly follow the specified GFCI requirements, wire type, wire thickness, compliance with NEC guidelines and local codes will void your warranty. This warranty does not cover acts of god or nature that can damage spa equipment, such examples are flooding, lightning strikes, wildfires, or other scenarios out of the control of the manufacturer.

## Plumbing

This limited warranty covers leaking of water through plumbing joints, tees, hoses, water features, and jet body grommets due to defects in workmanship and materials. This warranty does not cover damage caused by chemical abuse, improper water chemistry, or use of unapproved chemicals/sanitizers. This warranty does not cover freeze damage caused by frozen water expanding within the plumbing of the spa. The winterization procedure within this manual does not guarantee freeze damage prevention. The best method to ensure the spa does not encounter frozen water within the plumbing is to have the spa operating during the colder months of the year. This warranty does not cover freeze damage or damage to the plumbing due to acts of god and/or nature including but not limited too snowstorms, blizzards, power outages, etc. This warranty does not cover oxidation or warping of jets due to chemical abuse or exposing an empty spa to the elements with no secured cover.

## Spa Cabinet

This limited warranty covers defects in workmanship and materials of spa cabinet panels. This warranty applies for warping of spa panels, cracking of corners and panels without clear impact markers, and buckling of spa panels. This warranty does not cover natural wear and tear, which occurs with plastics exposed to the sun. This warranty does not cover panel damage from excessive heat sources, calcium/water-spot build up from sprinklers or irrigation systems, or impact damage. Each claim for spa cabinets are evaluated on a case by case basis, it is the responsibility of the spa owner to acknowledge environmental factors, that can affect the maintenance of the spas cabinet panels. Using plastic spa protectants can prolong the life of your spa panels is highly recommended in high UV index climates. Deterioration/fading of color, natural wear and tear of plastic materials is expected over time, and is not considered a defect in materials. This coverage does not extend nor cover acts of god or nature that can damage spa panels, such examples are flooding, high winds, wildfires, tornadoes or other scenarios out of the control of the manufacturer



**Sanitation**

This limited warranty covers malfunctions of factory installed Salt Systems and Bromine generators, which are warranted against malfunction due to defects in workmanship or materials. This includes the salt cell, sanitizer control panels, bromine generator, and power supplies for Cal Salt systems. This warranty does not cover negligent operation of sanitizer systems, chemical abuse, damage caused by improper water chemistry, or disregard of specified data points for safe operation; including but not limited to, incorrect ppm levels of salts, excess operating hours of the Cal Salt cell, or improper maintenance of sanitation components. The spa filter is not a part of this warranty, and is considered a disposable item subject to regular wear and tear.

**Ozone/UV Systems**

This limited warranty covers malfunctions of factory installed Ozone and/or UV water treatment systems. This includes leaks through welded components, water back-flow into the ozone generator, and short circuited Ozone or UV systems. This warranty does not cover UV bulbs that are older than 10 months, the UV light must be replaced every 10-12 months as this is normal wear and tear of component. This warranty is voided if alterations/modifications of these systems are evident, or if the spa electrical connections were not installed in accordance to defined specifications within this manual, evidence of chemical abuse, and acts of god and/or nature.

**Sound System**

This limited warranty covers malfunctions of factory installed sound system components. This includes the sub-woofer/amplifier, speakers, speaker grills, power supply, or Bluetooth antenna. Natural wear and tear of speaker cones is not covered by this warranty, nor are deterioration of speakers exposed to chemical abuse.

**Spa Cover**

The spa cover is warranted against defects of materials and workmanship for the defined period mentioned in this warranty. Exposure to UV rays on untreated or poorly maintained spa covers are not covered by this warranty. It is the responsibility of the spa owner to use spa UV plastic protectants on their spa covers, especially in high UV index climates. Exposure to UV light without proper treatment leads to problems such as cracking/peeling of vinyl covers, and sudden fading of color. This warranty does not warrant against damage caused by chemical abuse, nor yellowing or oxidation of the spa cover when exposed to excess sanitizer. If a defect is found within the first 90 days of ownership, your Cal Spas dealer and Cal Spas can directly assist the spa owner filing a claim and replacing the spa cover if deemed necessary. Spa owners with spa covers past the 90 day period that are discovered to have a defect, can contact your Cal Spa dealer to begin the process of filing a claim. When filing a claim of a spa cover than is older than 90 days, this warranty will cover the material cost of issuing a new vinyl sleeve for the cover, and/or replacement foam for your cover. Shipping/freight costs are not covered in this warranty, and are the sole responsibility of the spa owner. Images of the cover from all sides including the top and underside are necessary to file a claim.

**Genuine Cal Spas Parts & Accessories**

This Limited Warranty is void if Lloyd's Material Supply Company, Inc., Manufacturer of the Cal Spas brand or its designated representative determines that the spa has been subjected to damage or failure due to installation of aftermarket parts that are not genuine Cal Spas branded parts and accessories. This disclaimer includes, but is not limited to filters, UV bulbs, ozone systems, salt systems, replacement parts and other accessories. Genuine Cal Spas brand parts and accessories are built to our highest standards of quality, durability and performance, and they are designed to work with your spa to ensure optimal performance and function. Only parts/components approved by Cal Spas should used when performing a warranty repair. If parts are required to complete a warranty claim, the cost of the parts are covered by this warranty. Approved labor and genuine part costs are covered when a warranty claim is approved, the cost of shipping parts/components is not covered by this warranty, and its the sole responsibility of the spa owner.

## Performance

This warranty begins on the date of delivery of the spa, but in no event later than one year from the date of manufacture. To obtain service in the event of a defect covered by this Limited Warranty, notify your Cal Spas dealer or Cal spas as soon as possible and use all reasonable means to protect the spa from further damage. Upon proof of purchase, a designated service representative will correct the defect subject to the terms and conditions contained in this Limited Warranty. There will be no charge for parts or Labor to repair the defect, although providing access to affect the repair is your responsibility as the spa owner. Freight charges for replacement parts is the responsibility of the spa owner. Parts and components can be shipped to the servicing dealer or to the customer. The servicing dealer may charge the owner a travel/service fee as well as a diagnose fee if the cause of the issue is unknown, these charges are not covered under warranty. Your spa dealer nor Cal Spas is responsible for damages or costs to rebuild decks, cement structures, or other decor/structures placed against the sides of the spa. Minimum clearance of 3 feet on each side is mandatory for all spas. In the event that the spa is removed to a repair facility for repair and reinstalled, the cost of removal and re-installation will be your responsibility as the spa owner. If Lloyd's Material Supply Company Inc., The manufacture of the Cal Spa brand determines that repair of the covered defect is not feasible, it reserves the right to provide a replacement spa of equal or lesser value to the original purchase price. In such an event reasonable costs for removal of the original spa, shipping costs from the factory for the replacement spa, and delivery and installation of the replacement spa will be the responsibility of the spa owner. The replacement spa will carry the balance of the original spa's warranty. Spa covers are not included. This warranty ends either by specified time frame, owner-transfer of the spa, relocation, or installation of any component other than by the manufacture. If the desired spa is more expensive than what the spa owner originally financed or paid for, the price difference shall be paid by the spa owner. Additional costs can be incurred if the use of heavy machinery such as a crane, bulldozer, etc, is considered necessary to access, remove, or perform a repair/correction to the affected spa.

## Warranty limitations

This Limited Warranty is void if Cal Spas or its designated representative determines that the spa has been subjected to alteration, neglect, misuse or abuse, or freight damage caused by the common carrier; any repairs have been attempted by anyone other than a designated representative; or if the failure is caused by accident, acts of God or other causes beyond the control of the Manufacturer including acts of nature (damage caused by animals, rodents, or other pests) are not covered by this warranty. Additionally; the limited warranty is void for spas that were subject to neglect, misuse and abuse including any installation, operation or maintenance of the spa other than in accordance with the instructions contained in the owner's manual provided with the spa, including but not limited to the failure to maintain proper water chemistry, chemical balancing, the use of abrasives or improper cleaners, and the use of non-genuine parts and accessories. This Limited Warranty does not provide coverage for any item attached to or installed on the spa after the date of manufacture or for gaining access to any component for repair or replacement. Spa units in commercial use are excluded from any coverage whatsoever. The spa owner accepts liability for repair work performed by anyone other than Lloyd's Material Supply Company Inc, or a designated Cal Spas representative. This Limited Warranty is void if damage occurs to the spa shell because of excessive heat buildup due to failure to cover a spa that is empty of water while exposed to direct sunlight.

## Proration of Warranty

Units determined by the manufacture to be non-repairable will be replaced on a prorated basis with the same or a comparable unit. The owner will be charged 1% of the current retail cost for each full month of ownership from the date of purchase through the date failure is determined to be non-repairable. This charge will be waived during the first 6 months of ownership. [example]: Product failure is determined during seven months of ownership. Owner will be responsible to pay for 7% of the products current cost. As the spa owner you have the choice to replace the spa, with a spa equal to or less than the value of the originally financed/purchased spa; if the desired replacement spa is of a higher cost than the originally financed/purchased spa, the spa owner will pay the difference of price, including any percent value lost over time through the spas proration period. The cost of shipping a new spa and its installation is not covered by this warranty as stated in the "Performance" section of this warranty.

**Limitations**

The manufacture disclaims all warranties, expressed or implies, in fact or in law, to the extent allowed by your State’s law, including the warranty of merchantability and fitness for use, except as stated specifically herein. All warranty service must be performed by the manufacture or its designated representative using authorized Cal Spas parts. No agent, dealer, distributor, service company, or other party is authorized to change, modify, or extend the terms of this limited warranty in any manner whatsoever. The manufacture will not be responsible for any statements or representations made in any form that go beyond, are broader than, or are inconsistent with any authorized literature or specifications furnished by Cal Spas. Extended warranties or care plans offered to you by a spa dealer is an agreement strictly between the spa owner and the spa dealer, out of the control of the manufacture of Cal Spas.

**Disclaimers**

Lloyd’s Material Supply Company, Inc., Manufacture of Cal Spas brand and its representatives shall not be liable for any injury, loss, cost, or other damage whether incidental or consequential, arising out of any defect covered by this limited warranty, including without limitation, loss of use of the spa and cost for removal of defective produce even if the manufacture was advised of the possibility of damage. The liability of the manufacture under this limited warranty, if any shall not exceed the original amount paid for the defective product. Coverage under this limited warranty shall commence as of the original date of delivery and the duration of such coverage shall not extend for any reason whatsoever beyond the stated time periods. These disclaimers shall be equally applicable to any service provided by the manufacture and its designated representatives.

**Legal Rights**

This limited warranty gives you specific legal rights. You may also have other rights that vary from state to state depending on consumer regulations. Some states do not allow limitations on how long an implied warranty lasts, so this time limitation may not apply to you.

**Additional Disclaimers**

Spa owners who have purchased a Cal Spa, and the spas final resting place is not in the United States or Canada, Cal Spas will be able to send components and parts directly to the spa customer if the original Cal Spa dealer is not within range of the spa. It is the responsibility of the spa owner to find a experienced electrician, plumber, or technician to perform the necessary repairs. A preliminary over the phone technical meeting with a Cal Spas representative is necessary, to ensure the experienced laborer is familiar with the spas operation, and recommended repair methods. Labor costs of a repair in such circumstances must be first approved by a Cal Spas representative, before moving forward with any repairs covered in this warranty. It is advised to request a labor quote from said experienced laborer, and to send this quote to a Cal Spas representative. If all prerequisites are met and the repair is approved, Cal Spas will reimburse the cost of labor directly to the spa owner upon completion of repairs. Reimbursements of charged labor will be sent as a check to the spa owners residence, with a varying estimated disbursement window.

For all repairs/warranty claims within the United States and Canada and other nations, may be required to send parts/components back to Cal Spas when deemed necessary. In some circumstance where shipping the component/part is necessary, Cal Spas will provide a shipping label to send the affected or requested components/parts. It is the responsibility of the spa owner to properly package and secure the package for shipping. In some circumstances only images and proof of purchase would be necessary to file a warranty claim, in such circumstances if a Cal Spas representative deems that the parts do not have to be returned, follow all local regulations and laws to properly dispose of said components.



This Page is Intentionally Blank

This Page is Intentionally Blank





CONTACT INFORMATION

For customer service, please contact your authorized dealer immediately. If you need additional information and/or assistance, contact:

**Lloyd's Material Supply Company, Inc.**  
**Customer Service Department**  
**1462 East Ninth Street**  
**Pomona, CA 91766.**

Toll Free: 1-800-CAL-SPAS  
Fax: 1-909-629-3890